

FOCUS ON INNOVATION HUIDE SCIENCE & TECHNOLOGY 专注革新, 汇得科技

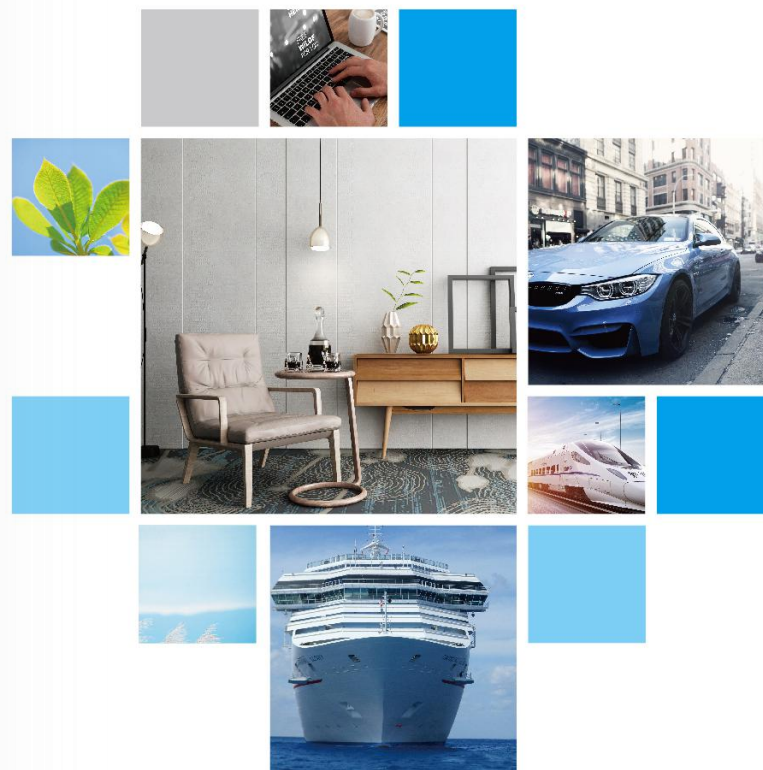

成为行业尊重、
国际优秀的科技型企业
TO BE AN INDUSTRY
RESPECTED, INTERNATIONAL
OUTSTANDING TECHNOLOGY
ENTERPRISE



CONTENTS 目录

公司简介 COMPANY PROFILE	02
革用聚氨酯树脂 PU RESIN FOR SYNTHETIC MATERIAL	04
湿法聚氨酯树脂 Wet Process Pu Resin	05
特殊用途湿法聚氨酯树脂 Special Purpose Wet Process Pu Resin	15
超纤含浸湿法聚氨酯树脂 Wet Process Pu Resin For Micro Fiber	18
干法面层聚氨酯树脂 Dry Process Pu Resin	19
干法底料聚氨酯树脂 Dry Adhesive Resin	28
直接涂层聚氨酯树脂 Pu Resin For Direct Coating	32
环境友好型聚氨酯树脂 Environmental Friendly Resin	33
特殊加工用聚氨酯树脂 Pu Resin For Special Processing	36
合成革用添加剂 Additive For Synthetic Material	38
聚酯多元醇 POLYESTER POLYOLS	40
工艺流程图 PROCESS FLOW DIAGRAM	44

公司简介

COMPANY PROFILE

上海汇得科技股份有限公司成立于2007年6月，最早可溯源至1997年创建的上海汇得化工有限公司，是一家集设计、研发、生产、销售和服务于一体，专业制造革用聚氨酯(PU)树脂、聚氨酯弹性体相关产品等系列新材料的科技型集团公司。经中国证监会核准，公司股票于2018年8月28日在上海证券交易所挂牌上市，股票代码603192，股票简称“汇得科技”。

汇得科技位于杭州湾北岸的上海精细化工产业园，旗下拥有福建汇得新材料有限公司、上海鸿得聚氨酯有限公司、常州普菲特化工有限公司、上海汇得国际贸易有限公司和常州韵祺运输有限公司等五家全资子公司，业务范围涵盖生产制造、国内贸易、国际贸易和物流运输等领域。

汇得科技作为国内革用聚氨酯树脂行业的领先企业，建有独立的技术研发中心，拥有一支由国内外专家领衔，由博士、硕士和本科生组成的技术研发队伍，已获得授权发明专利26项，有9个产品列入上海市高新技术成果转化项目。通过技术创新，不断实现高新技术成果转化，产品品质和技术达到国内一流、国际领先的水平。特别是按照“源头控制、低碳环保、节能减排”的要求，研发出了无溶剂和水性聚氨酯树脂等环保型产品，成功探索出一条产品转型升级的方向，促进了行业的可持续发展。公司通过了ISO9000、ISO14000、OHSAS18000三体系认证和清洁生产审核验收，先后获得了上海市高新技术企业、上海市企业技术中心、上海市科技小巨人企业、上海市五星级诚信创建企业、上海市名牌产品、上海市著名商标和上海市专利试点企业等荣誉称号。

面对瞬息万变的市场，汇得科技秉承自身优势，坚持以市场为主导，以人才为根本，产业经营和品牌经营相结合，实施以技术创新为中心，观念创新为先导，管理和机制创新为保障的创新工程，努力成为具有持续竞争优势的国际聚氨酯树脂行业的领跑者。

Shanghai Huide Science & Technology Co., Ltd. was established in June 2007 and can be traced back to the beginning of Shanghai Huide Chemical Co., Ltd. in 1997. It is a technology group corporation integrating design, R&D, production, sales and service in one and specializing in the production of synthetic material polyurethane (PU) resin, polyurethane elastomer and related products and materials. Approved by the China Securities Regulatory Commission (CSRC), the company's shares were listed on the Shanghai Stock Exchange on August 28, 2018. The stock code is 603192 and the abbreviated form of the company name is "Huide Technology".

Huide Technology is located in Shanghai Fine Chemical Industrial Park in the north of Hangzhou Bay. Huide owns five wholly-owned subsidiaries of Fujian Huide New Material co., LTD., Shanghai Hoard Polyurethane Co.,Ltd., Changzhou Pufeite Chemical Co.,Ltd., Shanghai Huide International Trade Co.,Ltd. and Changzhou Yunqi transportation Co., LTD.. Our business covers manufacturing, domestic trade, international trade, logistics, transportation and so on.

As a leading enterprise in polyurethane resin material in China, Huide Technology has set up an independent technology R&D center with a research and development team led by international and domestic outstanding professionals and composed of doctors, masters and undergraduates. So far 26 invention patents have been authorized and 9 products have been listed in Shanghai new and high technology transformation achievements. We are constantly realizing the transformation of high-tech achievements by technological innovation. At the same time, our products' quality and technology have reached a standard of first class in China and leading level internationally. In particular according to the requirements of "source control, low carbon and environmental protection, energy conservation and emission reduction", we have developed several eco-friendly products such as solvent-free and water-borne polyurethane resin and so on. We also have successfully explored a direction of transformation and upgrading of product and have promoted the sustainable development of the industry. Huide has passed the certification of ISO9000, ISO14000, OHSAS18000 system and the clean production audit and acceptance. Huide has successively won the Shanghai High and New Tech Enterprise, Shanghai Enterprise Technological Center, Shanghai Tech Little Giant Enterprise, Shanghai Five-star Integrity Enterprise, Shanghai Famous Brand Product, Shanghai Famous Trademark and Shanghai Patent Pilot Enterprise and other honorary titles.

When facing the rapidly changing market Huide in accordance with its own advantages is insisting on taking market as the leading factor, taking talents as the fundamental, combining industrial management with brand management. Huide is carrying out the innovation project with technological innovation as the core, idea innovation as the forerunner, management innovation as the foundation and mechanism innovation as the guarantee. Huide is striving to become a top runner with sustainable competitive advantage in international polyurethane resin industry.



革用聚氨酯树脂 POLYURETHANE RESIN FOR SYNTHETIC MATERIAL

革用聚氨酯树脂主要用于生产聚氨酯合成革，将革用聚氨酯通过涂覆或含浸等工艺与基布复合成型生产出多样化的聚氨酯合成革。汇得科技生产的革用聚氨酯树脂包括：无溶剂、超纤、水性、干法、湿法等十七大系列、500多个品种的产品。汇得科技的产品广泛应用于PVC人造革，PU合成革，超细纤维革及各种纺织复合材料等众多产品中。

Polyurethane resin for synthetic material is mainly used for producing polyurethane synthetic material which can be produced by combining and molding Polyurethane resin for synthetic material and ground cloth through coating or impregnation. Polyurethane resins for synthetic material produced by Huide include 17 series and more than 500 varieties of products such as solvent-free, micro fiber, water-borne, dry, wet and so on. Huide Technology's products are widely used in many products such as PVC synthetic material, PU synthetic material, micro fiber synthetic material and all kinds of textile composites.

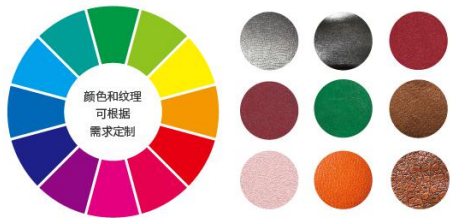

湿法聚氨酯树脂 WET PROCESS PU RESIN

常规系列湿法树脂 GENERAL WET PROCESS PU RESIN

规格 Specification	固含量 Solid Content(%)	粘度 Viscosity (10000 cps/25°C)	100%模量 100% Modulus (kg/cm ²)	抗张力 Tensile Strength (kg/cm ²)	伸长率 Elongation (%)	特性 Characteristic	用途 Uses
品名 Articles							
HDW-10EB	29~31	15~35	20~30	≥200	≥500	超软质,高泡,成膜性好 Super soft,Big cell,Good film thickness	服装,包 Garments,Bags
HDW-8010EB	29~31	15~35	20~30	≥200	≥600	超软质,高泡,剥离高,成膜性好 Super soft,Big cell,High peeling strength,Good film thickness	服装,鞋,包 Garments,Shoes,Bags
HDW-1122B	29~31	15~35	20~30	≥200	≥600	超软质,高泡,剥离高,成膜性好 Super soft,Big cell,High peeling strength,Good film thickness	服装,鞋,包,家具 Garments,Shoes,Bags,Furniture
HDW-3012	29~31	15~35	20~30	≥300	≥600	超软质,高泡,成膜性好 Super soft,Big cell,Good film thickness	服装,鞋,包,家具 Garments,Shoes,Bags,Furniture
HDW-3012A	29~31	15~35	20~30	≥300	≥600	超软质,高泡,成膜性好 Super soft,Big cell,Good film thickness	服装,鞋,包,家具 Garments,Shoes,Bags,Furniture
HDW-20C	29~31	15~35	25~35	≥200	≥500	软质,高泡,成膜性好 Soft,Big cell,Good film thickness	服装,鞋,包,家具 Garments,Shoes,Bags,Furniture
HDW-20	29~31	15~35	25~35	≥200	≥500	软质,高泡,成膜性好 Soft,Big cell,Good film thickness	服装,鞋,包,家具 Garments,Shoes,Bags,Furniture
HDW-30	29~31	15~35	25~35	≥200	≥500	软质,高泡,成膜性好 Soft,Big cell,Good film thickness	服装,鞋,包,家具 Garments,Shoes,Bags,Furniture
HDW-30B	29~31	15~35	30~40	≥300	≥500	软质,高泡,成膜性好,丰满型 Soft,Big cell,Good film thickness,Fullness	服装,鞋,包,家具 Garments,Shoes,Bags,Furniture
HDW-1120	29~31	15~35	30~40	≥200	≥400	软质,高泡,成膜性好,丰满型 Soft,Big cell,Good film thickness,Fullness	服装,鞋,包,家具 Garments,Shoes,Bags,Furniture
HDW-1150	29~31	15~35	45~55	≥300	≥500	软质,高泡,成膜性好,丰满型 Soft,Big cell,Good film thickness,Fullness	服装,鞋,包,家具 Garments,Shoes,Bags,Furniture
HDW-90B	29~31	15~35	100~130	≥300	≥300	中硬质,高泡,成膜性好 Medium hard,Big cell,Good film thickness	服装,鞋,包,家具 Garments,Shoes,Bags,Furniture
HDW-15CX	29~31	15~35	15~25	≥100	≥600	超软质,低泡,剥离高,成膜性好 Super soft,Small intensive cell,High peeling strength,Good film thickness	服装,鞋,包 Garments,Shoes,Bags
HDW-3005EB	29~31	15~35	20~30	≥300	≥600	超软质,低泡,丰满,绵感好,压花性好 Super soft,Small intensive cell, Fullness,Soft-cotton feeling, Good embossing effect	服装,鞋,包 Garments,Shoes,Bags

规格 Specification	固含量 Solid Content(%)	粘度 Viscosity (10000 cps/25°C)	100%模量 100% Modulus (kg/cm ²)	抗张力 Tensile Strength (kg/cm ²)	伸长率 Elongation (%)	特性 Characteristic	用途 Uses
品名 Articles							
HDW-3008EB	29~31	15~35	25~35	≥300	≥600	超软质,低泡,丰满,绵感好,压花性好 Super soft,Small intensive cell, Fullness, Soft-cotton feeling,Good embossing effect	服装,鞋,包 Garments,Shoes,Bags
HDW-1309EB	29~31	15~35	25~35	≥300	≥600	超软质,低泡,丰满,绵感好,压花性好 Super soft,Small intensive cell, Fullness, Soft-cotton feeling,Good embossing effect	服装,鞋,包 Garments,Shoes,Bags
HDW-1109EB	29~31	15~35	25~35	≥200	≥500	超软质,低泡,丰满,绵感好,压花性好 Super soft,Small intensive cell, Fullness, Soft-cotton feeling,Good embossing effect	服装,鞋,包 Garments,Shoes,Bags
HDW-5008EB	29~31	15~35	30~40	≥300	≥600	软质,细胞密集丰满型,绵感好,压花性好 Soft,Small intensive cell, Fullness, Soft-cotton feeling,Good embossing effect	服装,鞋,包 Garments,Shoes,Bags
HDW-1121EB	29~31	15~35	30~40	≥200	≥400	软质,低泡,丰满,绵感好,压花性好 Soft,Small intensive cell, Fullness,Soft-cotton feeling, Good embossing effect	服装,鞋,包,家具 Garments,Shoes,Bags,Furniture
HDW-4021EB	29~31	15~35	30~40	≥300	≥600	软质,低泡,丰满型,压花性好 Soft,Small intensive cell, Fullness, Good embossing effect	服装,鞋,包,家具 Garments,Shoes,Bags,Furniture
HDW-1151EB	29~31	15~35	50~60	≥200	≥400	中软质,低泡,丰满型,压花性好 Medium soft,Small intensive cell, Fullness, Good embossing effect	服装,鞋,包,家具 Garments,Shoes,Bags,Furniture
HDW-2051EB	29~31	15~35	50~60	≥300	≥400	中软质,低泡,丰满型,压花性好 Medium soft,Small intensive cell, Fullness, Good embossing effect	服装,鞋,包,家具 Garments,Shoes,Bags,Furniture
HDW-1351EB	29~31	15~35	60~70	≥300	≥400	中软质,低泡,丰满型,压花性好 Medium soft,Small intensive cell, Fullness, Good embossing effect	服装,鞋,包,家具 Garments,Shoes,Bags,Furniture
HDW-7309EB	31~33	15~35	25~35	≥300	≥700	软质,低泡,丰满型,压花性好 Soft,Small intensive cell, Fullness, Good embossing effect	服装,鞋,包,家具 Garments,Shoes,Bags,Furniture
HDW-7359EB	34~36	15~35	20~30	≥300	≥700	软质,低泡,丰满型,压花性好 Soft,Small intensive cell, Fullness, Good embossing effect	服装,鞋,包,家具 Garments,Shoes,Bags,Furniture
HDW-8025	34~36	15~35	30~40	≥300	≥600	软质,高填充,高剥离 Soft,High filling, High peeling serength	鞋,包 Shoes,Bags
HDW-8055	34~36	15~35	45~55	≥300	≥500	软质,高填充,高剥离 Soft,High filling, High peeling serength	鞋,包 Shoes,Bags
HDW-2100B	29~31	15~35	90~110	≥300	≥400	中硬质,低泡,成膜性好 Medium hard,Small intensive cell, Good film thickness	服装,鞋,包,家具 Garments,Shoes,Bags,Furniture
HDW-5050	29~31	15~35	45~55	≥300	≥400	中软质,低泡,成膜性好 Medium soft,Small intensive cell, Good film thickness	二榔皮 Split synthetic material

高剥离系列湿法树脂

WET PROCESS PU RESIN WITH HIGH PEELING STRENGTH

规格 Specification	固含量 Solid Content(%)	粘度 Viscosity (10000 cps/25°C)	100%模量 100% Modulus (kg/cm ²)	抗张力 Tensile Strength (kg/cm ²)	伸长率 Elongation (%)	特性 Characteristic	用途 Uses
品名 Articles							
HDW-5090B	29~31	15~35	90~110	≥300	≥300	中硬质,低泡,成膜性好 Medium hard,Small intensive cell, Good film thickness	二脚皮 Split synthetic material
HDW-240	29~31	15~35	250~330	≥300	≥200	硬质 Hard type	鞋,包 Shoes,Bags
HDW-300	29~31	15~35	250~330	≥300	≥200	硬质 Hard type	鞋,包 Shoes,Bags
HDW-400	29~31	15~35	350~420	≥300	≥100	极高硬度 Super hard type	鞋,包 Shoes,Bags

低泡系列湿法树脂

WET PROCESS PU RESIN WITH NON-CELL

规格 Specification	固含量 Solid Content(%)	粘度 Viscosity (10000 cps/25°C)	100%模量 100% Modulus (kg/cm ²)	抗张力 Tensile Strength (kg/cm ²)	伸长率 Elongation (%)	特性 Characteristic	用途 Uses
品名 Articles							
HDW-1115B	29~31	15~35	35~55	≥300	≥500	软质,回弹性好,无泡型 Soft,Good resilience,Non-cell	鞋,包 Shoes,Bags
HDW-4060B	34~36	15~35	70~90	≥300	≥400	中软质,回弹性好,无泡型 Medium soft,Good resilience,Non-cell	鞋,包 Shoes,Bags
HDW-5065B	29~31	15~35	55~65	≥300	≥500	中软质,回弹性好,无泡型 Medium soft,Good resilience,Non-cell	鞋,包 Shoes,Bags
HDW-1110	29~31	15~35	85~105	≥200	≥300	中硬质,回弹性好,无泡型 Medium hard,Good resilience,Non-cell	鞋,包 Shoes,Bags
HDW-2110B	29~31	15~35	80~100	≥300	≥400	中硬质,回弹性好,无泡型 Medium hard,Good resilience,Non-cell	鞋,包 Shoes,Bags
HDW-2200B	29~31	15~35	230~310	≥300	≥200	硬质,回弹性好,无泡型 Hard,Good resilience,Non-cell	鞋,包 Shoes,Bags
HDW-5060HB	29~31	15~35	80~100	≥300	≥300	中硬质,耐水解性好,回弹性好,无泡型 Medium hard,Good hydrolysis resistance, Good resilience,Non-cell	鞋,包 Shoes,Bags
HDW-5090HB	29~31	15~35	100~120	≥300	≥300	中硬质,耐水解性好,回弹性好,无泡型 Medium hard,Good hydrolysis resistance, Good resilience,Non-cell	鞋,包 Shoes,Bags

规格 Specification	固含量 Solid Content(%)	粘度 Viscosity (10000 cps/25°C)	100%模量 100% Modulus (kg/cm ²)	抗张力 Tensile Strength (kg/cm ²)	伸长率 Elongation (%)	特性 Characteristic	用途 Uses
品名 Articles							
HDW-30EC	29~31	15~35	30~40	≥300	≥600	软质,高剥离 Soft,High peeling strength	鞋 Shoes
HDW-1065	29~31	15~35	60~70	≥200	≥400	中软质,高剥离 Medium soft,High peeling strength	鞋 Shoes
HDW-506E	29~31	15~35	55~65	≥300	≥500	中软质,高剥离 Medium soft,High peeling strength	鞋 Shoes
HDW-80E	31~33	15~35	70~90	≥300	≥500	中硬质,高剥离 Medium hard,High peeling strength	鞋 Shoes
HDW-90E	29~31	15~35	90~110	≥300	≥300	中硬质,高剥离 Medium hard,High peeling strength	鞋 Shoes
HDW-120E	29~31	15~35	120~140	≥300	≥300	中硬质,高剥离 Medium hard,High peeling strength	鞋 Shoes
HDW-100YE	29~31	15~35	120~140	≥300	≥300	中硬质,高剥离,耐黄变 Medium Hard,High peeling strength, Yellowing resistance	鞋 Shoes
HDW-6606HE	29~31	15~35	65~75	≥200	≥400	中软质,高剥离,耐水解 Medium soft,High peeling strength, Hydrolysis resistance	鞋 Shoes
HDW-7012HEM	29~31	15~35	55~65	≥200	≥500	中软质,高剥离,耐水解 Medium soft,High peeling strength, Hydrolysis resistance	鞋 Shoes
HDW-1140HE	34~36	15~35	40~50	≥200	≥500	软质,耐水解性好,高剥离 Soft,Hydrolysis resistance,Good peeling strength	鞋 Shoes
HDW-1160HE	34~36	15~35	55~65	≥300	≥500	中软质,耐水解性好,高剥离 Medium soft,Good hydrolysis resistance, Good peeling strength	鞋 Shoes
HDW-7012AHM	29~31	15~35	55~65	≥200	≥500	中软质,高剥离,耐水解,环保型 Medium soft,High peeling strength, Hydrolysis resistance,Environmental friendly	鞋 Shoes
HDW-1140AHE	34~36	15~35	40~50	≥200	≥500	软质,耐水解性好,高剥离,环保型 Soft,Good hydrolysis resistance,Good peeling strength,Environmental friendly	鞋 Shoes
HDW-1160AHE	34~36	15~35	55~65	≥300	≥500	中软质,耐水解性好,高剥离,环保型 Medium soft,Good hydrolysis resistance, Good peeling strength,Environmental friendly	鞋 Shoes
HDW-7040HNF	34~36	15~35	35~45	≥300	≥400	软质,耐水解,高剥离,无氟 Soft,Hydrolysis resistance,Good peeling strength,Fluoride-free	鞋 Shoes

规格 Specification	固含量 Solid Content(%)	粘度 Viscosity (10000 cps/25°C)	100%模量 100% Modulus (kg/cm ²)	抗张力 Tensile Strength (kg/cm ²)	伸长率 Elongation (%)	特性 Characteristic	用途 Uses
品名 Articles							
HDW-7100HNF	34~36	15~35	95~115	≥200	≥400	中硬质,耐水解,高剥离,无氟 Medium hard,Hydrolysis resistance, Good peeling strength, Fluoride-free	鞋 Shoes
HDW-100HE	34~36	15~35	90~110	≥300	≥400	中硬质,耐水解性好,高剥离 Medium hard,Good hydrolysis resistance, High peeling strength	鞋 Shoes
HDW-100YHE	34~36	15~35	90~110	≥300	≥400	中硬质,耐水解性好,高剥离,耐黄变 Medium hard,Good hydrolysis resistance, High peeling strength, Yellowing resistance	鞋 Shoes
HDD-2708	29~31	2~8	10~20	≥50	≥700	含浸用,撕裂强度优秀 For dipping, Excellent tearing strength	鞋 Shoes
HDD-1130H	29~31	8~14	30~50	≥200	≥500	含浸用,耐水解性好,撕裂强度优秀 For dipping, Good hydrolysis resistance, Excellent tearing strength	鞋 Shoes
HDD-5130H	29~31	8~14	10~20	≥50	≥600	含浸用,耐水解性好,撕裂强度优秀 For dipping, Good hydrolysis resistance, Excellent tearing strength	鞋 Shoes
HDD-5030HNF	29~31	8~14	40~50	≥200	≥400	含浸用,耐水解,撕裂强度优秀,无氟 For dipping, Hydrolysis resistance, Excellent tearing strength, Fluoride-free	鞋 Shoes

NUBUCK系列湿法树脂 WET PROCESS PU RESIN FOR NUBUCK

规格 Specification	固含量 Solid Content(%)	粘度 Viscosity (10000 cps/25°C)	100%模量 100% Modulus (kg/cm ²)	抗张力 Tensile Strength (kg/cm ²)	伸长率 Elongation (%)	特性 Characteristic	用途 Uses
品名 Articles							
HDW-20M	29~31	15~35	25~35	≥200	≥600	超软质,绒感好 Super soft, Downy feeling	服装,鞋 Garments, Shoes
HDW-35M	29~31	15~35	35~45	≥200	≥500	软质,绒感好 Soft, Downy feeling	服装,鞋 Garments, Shoes
HDW-35MY	29~31	15~35	35~45	≥200	≥500	软质,绒感好,耐黄变 Soft, Downy feeling, Yellowing resistance	服装,鞋 Garments, Shoes
HDW-80M	29~31	15~35	70~90	≥300	≥400	中硬质,细腻感 Medium hard, Fine touch	鞋 Shoes
HDW-80ME	29~31	15~35	70~90	≥300	≥400	中硬质,高剥离,绒感好 Medium hard, High peeling strength, Downy feeling	鞋 Shoes
HDW-120M	29~31	15~35	90~110	≥300	≥300	中硬质,绒感好 Medium hard, Downy feeling	鞋 Shoes

规格 Specification	固含量 Solid Content(%)	粘度 Viscosity (10000 cps/25°C)	100%模量 100% Modulus (kg/cm ²)	抗张力 Tensile Strength (kg/cm ²)	伸长率 Elongation (%)	特性 Characteristic	用途 Uses
品名 Articles							
HDW-5035HM	34~36	15~35	40~50	≥200	≥500	软质,高剥离,绒感好,耐水解性好 Soft, High peeling strength, Downy feeling, Good hydrolysis resistance	鞋 Shoes
HDW-5065HM	34~36	15~35	55~65	≥300	≥500	中软质,高剥离,绒感好,耐水解性好 Medium soft, High peeling strength, Downy feeling, Good hydrolysis resistance	鞋 Shoes
HDW-6035HM	29~31	15~35	35~45	≥200	≥500	软质,绒感好,耐水解,展色性好 Soft, Downy feeling, Hydrolysis resistance, Good pigment dispersion	鞋 Shoes
HDW-6080HM	29~31	15~35	70~90	≥300	≥400	中硬质,绒感好,耐水解,展色性好 Medium hard, Downy feeling, Hydrolysis resistance, Good pigment dispersion	鞋 Shoes

烙印变色湿法树脂 WET PROCESS PU RESIN FOR EMBOSING DISCOLORATION

规格 Specification	固含量 Solid Content(%)	粘度 Viscosity (10000 cps/25°C)	100%模量 100% Modulus (kg/cm ²)	抗张力 Tensile Strength (kg/cm ²)	伸长率 Elongation (%)	特性 Characteristic	用途 Uses
品名 Articles							
HDW-40S	33~35	15~35	35~45	≥300	≥600	软质,烙印变色佳,丰满型 Soft, Good embossing discoloration, Fullness	标签,包装 Label, Packing
HDW-1140S	29~31	15~35	35~55	≥300	≥500	软质,低温烙印变色佳 Soft, Good embossing discoloration with low temperature	标签,包装 Label, Packing
HDW-80S	31~33	15~35	70~90	≥300	≥400	中硬质,烙印变色佳,丰满型,成膜性好 Medium hard, Good embossing discoloration, Fullness, Good film thickness	标签,包装 Label, Packing
HDW-2080S	29~31	15~35	80~100	≥300	≥300	中硬质,烙印变色佳,丰满型,成膜性好 Medium hard, Good embossing discoloration, Fullness, Good film thickness	标签,包装 Label, Packing
HDW-3082S	29~31	15~35	70~90	≥300	≥400	中硬质,成膜性好,烙印变色佳 Medium hard, Good film thickness, Good embossing discoloration	标签,包装 Label, Packing
HDW-4082S	29~31	15~35	80~100	≥300	≥300	中硬质,成膜性好,烙印变色佳 Medium hard, Good film thickness, Good embossing discoloration	标签,包装 Label, Packing
HDW-180S	29~31	15~35	130~170	≥300	≥300	硬质,烙印变色佳 Hard, Good embossing discoloration	标签,包装 Label, Packing
HDW-4150S	29~31	15~35	160~210	≥300	≥200	硬质,烙印变色佳 Hard, Good embossing discoloration	标签,包装 Label, Packing

规格 Specification	固含量 Solid Content (%)	粘度 Viscosity (10000 cps/25°C)	100%模量 100% Modulus (kg/cm ²)	抗张力 Tensile Strength (kg/cm ²)	伸长率 Elongation (%)	特性 Characteristic	用途 Uses
品名 Articles							
HDW-1240S	29~31	15~35	180~240	≥300	≥200	硬质, 烙印变色佳 Hard, Good embossing discoloration	标签, 包装 Label, Packing
HDW-5080HS	29~31	15~35	80~100	≥300	≥300	中硬质, 耐水解, 烙印变色佳 Medium hard, Hydrolysis resistance, Good embossing discoloration	标签, 包装 Label, Packing

耐水解系列湿法树脂

WET PROCESS PU RESIN WITH HYDROLYSIS RESISTANCE

规格 Specification	固含量 Solid Content (%)	粘度 Viscosity (10000 cps/25°C)	100%模量 100% Modulus (kg/cm ²)	抗张力 Tensile Strength (kg/cm ²)	伸长率 Elongation (%)	特性 Characteristic	用途 Uses
品名 Articles							
HDW-5009H	29~31	15~35	25~35	≥200	≥800	超软质, 耐水解, 成膜性好 Super soft, Hydrolysis resistance, Good film thickness	服装, 鞋, 家具 Garments, Shoes, Furniture
HDW-8005H	29~31	15~35	20~30	≥200	≥600	超软质, 耐水解性好, 成膜性好 Super soft, Good hydrolysis resistance, Good film thickness	服装, 鞋, 家具 Garments, Shoes, Furniture
HDW-7010H	29~31	15~35	25~35	≥200	≥800	超软质, 耐水解性好, 成膜性好 Super soft, Good hydrolysis resistance, Good film thickness	服装, 鞋, 家具 Garments, Shoes, Furniture
HDW-1110H	29~31	15~35	35~45	≥200	≥500	软质, 耐水解性好, 成膜性好 Soft, Good hydrolysis resistance, Good film thickness	服装, 鞋, 家具 Garments, Shoes, Furniture
HDW-1250H	32~34	15~35	45~55	≥200	≥500	中软质, 耐水解性好, 高剥离, 成膜性好 Medium soft, Good hydrolysis resistance, High peeling strength, Good film thickness	鞋, 家具 Shoes, Furniture
HDW-2150H	31~33	15~35	100~130	≥300	≥300	中硬质, 耐水解性好, 成膜性好 Medium hard, Good hydrolysis resistance, Good film thickness	鞋, 家具 Shoes, Furniture
HDW-8008H	29~31	15~35	25~35	≥200	≥600	超软质, 耐水解性好, 成膜性好 Super soft, Good hydrolysis resistance, Good film thickness	服装, 鞋, 家具 Garments, Shoes, Furniture
HDW-8025H	29~31	15~35	35~45	≥200	≥500	中软质, 耐水解性好, 高剥离, 成膜性好 Medium soft, Good hydrolysis resistance, High peeling strength, Good film thickness	鞋, 家具 Shoes, Furniture
HDW-8050H	29~31	15~35	45~55	≥200	≥500	中软质, 耐水解性好, 高剥离, 成膜性好 Medium soft, Good hydrolysis resistance, High peeling strength, Good film thickness	鞋, 家具 Shoes, Furniture
HDW-3023F	29~31	15~35	40~50	≥250	≥500	软质, 耐水解, 成膜性好 Soft, Hydrolysis resistance, Good film thickness	家具 Furniture
HDW-3025F	29~31	15~35	35~45	≥200	≥500	中软质, 耐水解性好, 成膜性好 Medium soft, Good hydrolysis resistance, Good film thickness	家具 Furniture

规格 Specification	固含量 Solid Content (%)	粘度 Viscosity (10000 cps/25°C)	100%模量 100% Modulus (kg/cm ²)	抗张力 Tensile Strength (kg/cm ²)	伸长率 Elongation (%)	特性 Characteristic	用途 Uses
品名 Articles							
HDW-7025F	29~31	15~35	35~45	≥200	≥500	中软质, 耐水解性好, 成膜性好 Medium soft, Good hydrolysis resistance, Good film thickness	家具 Furniture
HDW-3029F	29~31	15~35	40~50	≥300	≥600	中软质, 耐水解性好, 成膜性好 Medium soft, Good hydrolysis resistance, Good film thickness	家具 Furniture
HDW-7010F	24~26	15~35	30~40	≥300	≥500	软质, 耐老化, 成膜性好 Soft, Aging resistance, Good film thickness	车辆 Vehicle

仿超纤系列湿法树脂

WET PROCESS PU RESIN FOR IMITATION MICRO FIBER

规格 Specification	固含量 Solid Content (%)	粘度 Viscosity (10000 cps/25°C)	100%模量 100% Modulus (kg/cm ²)	抗张力 Tensile Strength (kg/cm ²)	伸长率 Elongation (%)	特性 Characteristic	用途 Uses
品名 Articles							
HDD-3503C	34~36	9~18	10~20	≥200	≥700	超软质, 低回弹, 丰满型, 成膜性好 Super soft, Low resilience, Fullness, Good film thickness	服装, 鞋, 包, 家具 Garments, Shoes, Bags, Furniture
HDD-3509C	34~36	7~14	20~30	≥300	≥800	软质, 低回弹, 丰满型, 成膜性好 Soft, Low resilience, Fullness, Good film thickness	服装, 鞋, 包, 家具 Garments, Shoes, Bags, Furniture
HDD-1121	29~31	8~14	25~35	≥300	≥600	软质, 成膜性好 Soft, Good film thickness	服装, 鞋, 包, 家具 Garments, Shoes, Bags, Furniture
HDD-6011	29~31	8~14	25~35	≥300	≥600	超软质, 垂感好, 成膜性好 Super soft, Good drapability, Good film thickness	服装, 鞋, 包, 家具 Garments, Shoes, Bags, Furniture
HDD-6015C	29~31	15~35	25~35	≥300	≥600	软质, 低回弹, 垂感好, 成膜性好 Soft, Low resilience, Good drapability, Good film thickness	服装, 鞋, 包, 家具 Garments, Shoes, Bags, Furniture
HDD-5005H	29~31	15~35	20~30	≥200	≥600	软质, 成膜性好, 耐水解 Soft, Good film thickness, Hydrolysis resistance	服装, 鞋, 包, 家具 Garments, Shoes, Bags, Furniture
HDD-5015H	29~31	15~35	20~30	≥200	≥600	软质, 成膜性好, 耐水解性好 Soft, Good film thickness, Good hydrolysis resistance	服装, 鞋, 包, 家具 Garments, Shoes, Bags, Furniture
HDD-5025H	29~31	15~35	25~35	≥200	≥600	软质, 成膜性好, 耐水解性好 Soft, Good film thickness, Good hydrolysis resistance	服装, 鞋, 包, 家具 Garments, Shoes, Bags, Furniture
HDD-5095H	29~31	15~35	10~20	≥200	≥800	超软质, 低回弹, 丰满型, 耐水解性好 Super soft, Low resilience, Fullness, Good hydrolysis resistance	服装, 鞋, 包, 家具 Garments, Shoes, Bags, Furniture
HDD-5120H	29~31	15~35	10~20	≥200	≥700	超软质, 低回弹, 丰满型, 耐水解性好 Super soft, Low resilience, Fullness, Good hydrolysis resistance	服装, 鞋, 包, 家具 Garments, Shoes, Bags, Furniture

规格 Specification	固含量 Solid Content(%)	粘度 Viscosity (10000 cps/25°C)	100%模量 100% Modulus (kg/cm ²)	抗张力 Tensile Strength (kg/cm ²)	伸长率 Elongation (%)	特性 Characteristic	用途 Uses
品名 Articles							
HDD-7095H	29~31	15~35	15~25	≥200	≥700	超软质,低回弹,丰满型,耐水解性好 Super soft,Low resilience,Fullness, Good hydrolysis resistance	服装,鞋,包,家具 Garments,Shoes, Bags,Furniture
HDD-7120H	29~31	15~35	10~20	≥200	≥700	超软质,低回弹,丰满型,耐水解性好 Super soft,Low resilience,Fullness, Good hydrolysis resistance	服装,鞋,包,家具 Garments,Shoes, Bags,Furniture
HDD-7005H	29~31	15~35	20~30	≥200	≥600	软质,成膜性好,耐水解性好 Soft,Good film thickness, Good hydrolysis resistance	服装,鞋,包,家具 Garments,Shoes, Bags,Furniture
HDD-7021H	29~31	15~35	20~30	≥200	≥700	软质,低回弹,丰满型,耐水解性好 Soft,Low resilience,Fullness, Good hydrolysis resistance	服装,鞋,包,家具 Garments,Shoes, Bags,Furniture

含浸手套系列湿法树脂

WER PROCESS PU RESIN FOR DIPPING GLOVE

规格 Specification	固含量 Solid Content(%)	粘度 Viscosity (10000 cps/25°C)	100%模量 100% Modulus (kg/cm ²)	抗张力 Tensile Strength (kg/cm ²)	伸长率 Elongation (%)	特性 Characteristic	用途 Uses
品名 Articles							
HDW-30L	25~27	15~35	35~45	≥200	≥400	软质,耐磨好 Soft,Good abrasion resistance	手套 Glove
HDW-50L	26~28	15~35	50~60	≥300	≥400	中软质,耐磨好 Medium soft,Good abrasion resistance	手套 Glove
HDW-80L	25~27	15~35	65~85	≥300	≥300	中硬质,耐磨好 Medium hard,Good abrasion resistance	手套 Glove
HDW-1021L	31~33	15~35	30~40	≥300	≥500	超软质,成膜性好 Super soft,Good film thickness	手套 Glove
HDW-1021LX	31~33	15~35	35~45	≥300	≥700	超软质,成膜性好 Super soft,Good film thickness	手套 Glove
HDW-1035L	29~31	15~35	35~45	≥300	≥300	软质,成膜性好 Soft,Good film thickness	手套 Glove
HDW-2035L	29~31	15~35	35~45	≥300	≥600	软质,渗透少,成膜性好 Soft,Less penetration,Good film thickness	手套 Glove
HDW-3040L	29~31	15~35	40~50	≥300	≥600	中软质,成膜性好 Medium soft,Good film thickness	手套 Glove
HDW-3045L	29~31	15~35	40~50	≥300	≥500	中软质,成膜性好,耐磨好 Medium soft,Good film thickness, Good abrasion resistance	手套 Glove

规格 Specification	固含量 Solid Content(%)	粘度 Viscosity (10000 cps/25°C)	100%模量 100% Modulus (kg/cm ²)	抗张力 Tensile Strength (kg/cm ²)	伸长率 Elongation (%)	特性 Characteristic	用途 Uses
品名 Articles							
HDW-3046L	29~31	15~35	45~55	≥300	≥500	中软质,渗透少,耐磨好 Medium soft,Less penetration, Good abrasion resistance	手套 Glove
HDW-3013L	34~36	15~35	30~40	≥300	≥600	高固,成膜性好,耐磨好 High solid,Good film thickness, Good abrasion resistance	手套 Glove
HDW-4030L	29~31	15~35	20~30	≥300	≥600	超软质,成膜性好,脱模好 Super soft,Good film thickness, Good mold release	手套 Glove
HDW-4045L	29~31	15~35	40~50	≥300	≥500	中软质,光泽高,脱模好 Medium soft,High gloss, Good mold release	手套 Glove
HDW-5046L	29~31	15~35	50~60	≥300	≥500	中软质,光泽高,脱模好 Medium soft,High gloss, Good mold release	手套 Glove
HDW-6036L	29~31	15~35	40~50	≥300	≥500	软质,光泽好,渗透少 Soft, Good gloss,Less penetration	手套 Glove
HDW-6045L	29~31	15~35	45~55	≥300	≥600	中软质,光泽好,渗透少 Medium soft,Good gloss, Less penetration	手套 Glove
HDW-9305L	29~31	15~35	40~50	≥300	≥500	无DMF,成膜性好,耐磨好 NO DMF,Good film thickness, Good abrasion resistance	手套 Glove
HDW-4035NDL	29~31	15~35	35~45	≥300	≥500	无DMF,中软质,脱模好 NO DMF,Medium soft,Good mold release	手套 Glove
HDW-6050L	29~31	15~35	55~65	≥300	≥400	中硬质,耐磨好 Medium hard,Good abrasion resistance	手套 Glove
HDW-7025L	29~31	15~35	20~30	≥200	≥700	超软质,止滑好,渗透少 Super soft,Good slip-resistance, Less penetration	手套 Glove
HDW-7030L	29~31	15~35	35~45	≥300	≥600	软质,渗透少,耐磨好 Soft,Less penetration, Good abrasion resistance	手套 Glove
HDW-7035LB	29~31	15~35	35~45	≥300	≥600	软质,成膜好,脱模好 Soft,Good film thickness, Good mold release	手套 Glove
HDW-7040L	29~31	15~35	20~30	≥200	≥700	软质,止滑好,脱模好 Soft,Good slip-resistance, Good mold release	手套 Glove
HDW-7045L	29~31	15~35	40~50	≥300	≥600	中软质,止滑好,脱模好 Medium soft,Good slip-resistance, Good mold release	手套 Glove

特殊用途湿法聚氨酯树脂 SPECIAL PURPOSE WET PROCESS PU RESIN

压纹手套系列湿法树脂 WET PROCESS PU RESIN FOR EMBOSSING GLOVE

规格 Specification	固含量 Solid Content (%)	粘度 Viscosity (10000 cps/25°C)	100%模量 100% Modulus (kg/cm ²)	抗张力 Tensile Strength (kg/cm ²)	伸长率 Elongation (%)	特性 Characteristic	用途 Uses
品名 Articles							
HDW-10LF	29~31	15~35	20~30	≥200	≥500	压纹性好, 湿涩感强 Good embossing, Wet touch	手套 Glove
HDW-15LF	29~31	15~35	10~15	≥300	≥700	耐水解, 压纹性好, 湿涩感强 Hydrolysis resistance, Good embossing, Wet touch	手套 Glove
HDW-20LF	29~31	15~35	25~35	≥200	≥600	压纹性好, 湿涩感强 Good embossing, Wet touch	手套 Glove
HDW-6015HLF	29~31	15~35	25~35	≥200	≥800	耐水解, 压纹性好, 湿涩感强 Hydrolysis resistance, Good embossing, Wet touch	手套 Glove

运动系列湿法树脂 WET PROCESS PU RESIN FOR SPORT

规格 Specification	固含量 Solid Content (%)	粘度 Viscosity (10000 cps/25°C)	100%模量 100% Modulus (kg/cm ²)	抗张力 Tensile Strength (kg/cm ²)	伸长率 Elongation (%)	特性 Characteristic	用途 Uses
品名 Articles							
HDW-4020LF	29~31	15~35	25~35	≥200	≥600	软质, 细泡, 止滑感好 Soft, Intensive cell, Nonslip	握把, 瑜伽垫 Grip, Yoga mat
HDW-5035LF	29~31	15~35	35~45	≥200	≥500	软质, 细泡, 止滑感好 Soft, Intensive cell, Nonslip	握把, 瑜伽垫 Grip, Yoga mat
HDW-6050LF	29~31	15~35	55~65	≥300	≥500	软质, 粘感好, 止滑感好 Soft, Sticky touch, Nonslip	握把 Grip
HDW-6050YLF	29~31	15~35	55~65	≥300	≥500	软质, 止滑感好, 粘感好, 耐黄变 Soft, Nonslip, Sticky touch, Yellowing resistance	握把 Grip
HDW-7021LF	29~31	15~35	30~40	≥200	≥400	软质, 成膜性好, 止滑感好 Soft, Good film thickness, Nonslip	握把, 瑜伽垫 Grip, Yoga mat
HDW-7021TL	29~31	15~35	30~40	≥200	≥400	软质, 成膜性好, 粘感好 Soft, Good film thickness, Sticky touch	握把, 瑜伽垫 Grip, Yoga mat

球革系列湿法树脂 WET PROCESS PU RESIN FOR BALL

规格 Specification	固含量 Solid Content (%)	粘度 Viscosity (10000 cps/25°C)	100%模量 100% Modulus (kg/cm ²)	抗张力 Tensile Strength (kg/cm ²)	伸长率 Elongation (%)	特性 Characteristic	用途 Uses
品名 Articles							
HDW-1120B	29~31	15~35	25~45	≥300	≥500	软质, 压花性好, 回弹性好 Soft, Good embossing effect, Good resilience	手球 Handball
HDW-4055B	29~31	15~35	40~50	≥300	≥500	中软质, 压花性好, 回弹性好 Medium soft, Good embossing effect, Good resilience	篮球 Basketball
HDW-7020B	29~31	15~35	30~40	≥200	≥400	软质, 压花性好, 回弹性好 Medium soft, Good embossing effect, Good resilience	篮球 Basketball
HDW-8030B	29~31	15~35	35~45	≥300	≥500	软质, 压花性好, 回弹性好, 软化点低 Medium soft, Good embossing effect, Good resilience, Low softening point	篮球 Basketball
HDW-4050FB	29~31	15~35	40~60	≥300	≥500	中软质, 回弹性好 Medium soft, Good resilience	足球 Football
HDW-4100FB	29~31	15~35	80~100	≥300	≥400	中硬质, 回弹性好 Medium hard, Good resilience	足球 Football

蛋白质革系列湿法树脂 WET PROCESS PU RESIN FOR PROTEIN SYNTHETIC MATERIAL

规格 Specification	固含量 Solid Content (%)	粘度 Viscosity (10000 cps/25°C)	100%模量 100% Modulus (kg/cm ²)	抗张力 Tensile Strength (kg/cm ²)	伸长率 Elongation (%)	特性 Characteristic	用途 Uses
品名 Articles							
HDW-6009SS	27~29	1~3	—	—	—	超软质, 成膜性好, 绵感好 Super soft, Good film thickness, Soft-cotton feeling	蛋白质革 Protein synthetic material
HDW-7003HS	27~29	1~3	—	—	—	超软质, 耐水解, 绵感好 Super soft, Hydrolysis resistance, Soft-cotton feeling	蛋白质革 Protein synthetic material

粉扑革系列湿法树脂

WET PROCESS PU RESIN FOR POWDER-PUFF SYNTHETIC MATERIAL

规格 Specification	固含量 Solid Content (%)	粘度 Viscosity (10000 cps/25°C)	100%模量 100% Modulus (kg/cm ²)	抗张力 Tensile Strength (kg/cm ²)	伸长率 Elongation (%)	特性 Characteristic	用途 Uses
品名 Articles							
HDW-7220LV	31~33	8~14	20~30	≥200	≥600	软质,低泡,回弹好 Soft,Small intensive cell, Good resilience	剥离革 Peeling synthetic material
HDW-6500LV	31~33	8~14	45~55	≥300	≥500	中软质,低泡,回弹好 Medium soft,Small intensive cell, Good resilience	剥离革 Peeling synthetic material
HDW-6500VLV	31~33	8~14	45~55	≥300	≥500	中软质,低泡,回弹性好,耐黄变 Medium soft,Small intensive cell,Good resilience,Yellowing resistance	剥离革 Peeling synthetic material
HDW-8500	29~31	10~25	45~55	≥300	≥500	中软质,细泡,耐磨性好 Medium soft,Intensive cell, Abrasion resistance	磨砂剥离革 Frosted peeling synthetic material
HDW-8700	29~31	10~25	100~130	≥300	≥400	中硬质,细泡,耐磨性好 Medium hard,Intensive cell, Abrasion resistance	磨砂剥离革 Frosted peeling synthetic material
HDW-6003HS	27~29	1~3	—	—	—	超软质,网状多层型泡孔,棉感好 Super soft,Reticular cell, Soft-cotton feeling	磨砂粉扑 Frosted powder-puff

打磨革系列湿法树脂

WET PROCESS PU RESIN FOR POLISHED SYNTHETIC MATERIAL

规格 Specification	固含量 Solid Content (%)	粘度 Viscosity (10000 cps/25°C)	100%模量 100% Modulus (kg/cm ²)	抗张力 Tensile Strength (kg/cm ²)	伸长率 Elongation (%)	特性 Characteristic	用途 Uses
品名 Articles							
HDW-1050PW	39~41	1~4	40~60	≥300	≥500	中软质,成膜性好,耐磨性好 Medium soft,Good film thickness, Abrasion resistance	打磨革 Polished synthetic material
HDW-1150PW	39~41	1~4	140~180	≥300	≥300	中硬质,成膜性好,耐磨性好 Medium hard,Good film thickness, Abrasion resistance	打磨革 Polished synthetic material
HDW-1300PW	39~41	1~4	280~360	≥200	≥100	高硬质,成膜性好,耐磨性好 Super hard,Good film thickness, Abrasion resistance	打磨革 Polished synthetic material

超纤含浸湿法聚氨酯树脂

WET PROCESS PU RESIN FOR MICRO FIBER

甲苯减量超纤含浸系列湿法树脂

WET PROCESS PU RESIN FOR TOL REDUCTION MICRO FIBER

规格 Specification	固含量 Solid Content (%)	粘度 Viscosity (10000 cps/25°C)	100%模量 100% Modulus (kg/cm ²)	抗张力 Tensile Strength (kg/cm ²)	伸长率 Elongation (%)	特性 Characteristic	用途 Uses
品名 Articles							
HDD-3025T	29~31	5~10	25~35	≥300	≥600	软质,厚实感强,耐甲苯 Soft,Thick hand feeling, Toluene resistance	鞋,包,家具 Shoes,Bags, Furniture
HDD-2060T	29~31	5~10	65~85	≥300	≥400	中软质,厚实感强,耐甲苯 Medium soft,Thick hand feeling, Toluene resistance	鞋,包,家具 Shoes,Bags, Furniture
HDD-2100T	29~31	5~10	90~110	≥300	≥300	中硬质,厚实感强,耐甲苯 Medium hard,Thick hand feeling, Toluene resistance	鞋,包,家具 Shoes,Bags, Furniture
HDD-2030HT	29~31	5~10	25~35	≥300	≥700	软质,厚实感强,耐水解,耐甲苯 Soft,Thick hand feeling,Hydrolysis resistance,Toluene resistance	鞋,包,家具 Shoes,Bags, Furniture
HDD-6060HT	29~31	5~10	50~70	≥300	≥500	中软质,厚实感强,耐水解,耐甲苯 Medium soft,Thick hand feeling,Hydrolysis resistance,Toluene resistance	鞋,包,家具 Shoes,Bags, Furniture
HDD-8090HT	29~31	5~10	80~100	≥300	≥400	中硬质,厚实感强,耐水解,耐甲苯 Medium hard,Thick hand feeling,Hydrolysis resistance,Toluene resistance	鞋,包,家具 Shoes,Bags, Furniture
HDD-7063HT	29~31	8~14	55~75	≥300	≥400	中软质,厚实感强,耐水解,耐甲苯 Medium soft,Thick hand feeling,Hydrolysis resistance,Toluene resistance	鞋,包,家具 Shoes,Bags, Furniture
HDD-7133HT	29~31	8~14	110~150	≥300	≥300	硬质,厚实感强,耐水解,耐甲苯 Hard,Thick hand feeling,Hydrolysis resistance, Toluene resistance	鞋,包,家具 Shoes,Bags, Furniture
HDD-8030HT	29~31	8~14	30~50	≥300	≥600	软质,高回弹,耐水解,耐甲苯 Soft,High resilience,Hydrolysis resistance, Toluene resistance	鞋,包,家具 Shoes,Bags, Furniture
HDD-8060HT	29~31	8~14	50~70	≥300	≥500	中软质,高回弹,耐水解,耐甲苯 Medium soft,High resilience,Hydrolysis resistance,Toluene resistance	鞋,包,家具 Shoes,Bags, Furniture
HDD-8120HT	29~31	8~14	105~125	≥300	≥300	中硬质,高回弹,耐水解,耐甲苯 Medium hard,High resilience,Hydrolysis resistance,Toluene resistance	鞋,包,家具 Shoes,Bags, Furniture
HDD-8135HT	34~36	8~14	100~140	≥300	≥300	硬质,高固,厚实感强,耐水解,耐甲苯 Hard,High solid content,Thick hand feeling, Hydrolysis resistance,Toluene resistance	鞋,包,家具 Shoes,Bags, Furniture

碱减量超纤含浸系列湿法树脂

WET PROCESS PU RESIN FOR ALKALI REDUCTION MICRO FIBER

规格 Specification	固含量 Solid Content(%)	粘度 Viscosity (10000 cps/25°C)	100%模量 100% Modulus (kg/cm ²)	抗张力 Tensile Strength (kg/cm ²)	伸长率 Elongation (%)	特性 Characteristic	用途 Uses
品名 Articles							
HDD-4035H	29~31	5~10	30~40	≥300	≥600	软质,耐水解,耐酸,耐碱 Soft,Hydrolysis resistance,Acid-proof, Alkali-proof	鞋,包,家具 Shoes,Bags, Furniture
HDD-4060H	29~31	5~10	55~65	≥300	≥400	中软质,耐水解,耐酸,耐碱 Medium soft,Hydrolysis resistance, Acid-proof,Alkali-proof	鞋,包,家具 Shoes,Bags, Furniture
HDD-4090H	29~31	5~10	80~100	≥300	≥500	中硬质,耐水解,耐酸,耐碱 Medium hard,Hydrolysis resistance, Acid-proof,Alkali-proof	鞋,包,家具 Shoes,Bags, Furniture
HDD-4025HD	29~31	5~10	20~30	≥300	≥600	超软质,染色性好,耐水解,耐酸,耐碱 Super soft, Good dyeing effect, Hydrolysis resistance, Acid-proof, Alkali-proof	服装,鞋,包 Garments,Shoes, Bags
HDD-3090H	29~31	5~10	110~130	≥300	≥300	中硬质,染色性好,耐水解,耐酸,耐碱 Medium hard,Good dyeing effect,Hydrolysis resistance,Acid-proof,Alkali-proof	鞋,包,家具 Shoes,Bags, Furniture

干法面层聚氨酯树脂

DRY PROCESS PU RESIN

常规面层树脂

GENERAL DRY PROCESS PU RESIN

规格 Specification	固含量 Solid Content(%)	粘度 Viscosity (10000 cps/25°C)	100%模量 100% Modulus (kg/cm ²)	抗张力 Tensile Strength (kg/cm ²)	伸长率 Elongation (%)	特性 Characteristic	用途 Uses
品名 Articles							
HDS-10	29~31	8~14	20~30	≥200	≥600	超软质,低粘性 Super soft,Less-tacky	服装,鞋,包 Garments,Shoes, Bags
HDS-30	29~31	8~14	35~45	≥200	≥400	软质,低粘性 Soft,Less-tacky	服装,鞋,包,家具 Garments,Shoes, Bags,Furniture
HDS-50	29~31	8~14	35~45	≥200	≥400	软质,低粘性 Soft,Less-tacky	服装,鞋,包,家具 Garments,Shoes, Bags,Furniture
HDS-5030T	29~31	8~14	20~30	≥200	≥700	软质,清爽 Soft,Slippery	服装,鞋,包,家具 Garments,Shoes, Bags,Furniture

规格 Specification	固含量 Solid Content(%)	粘度 Viscosity (10000 cps/25°C)	100%模量 100% Modulus (kg/cm ²)	抗张力 Tensile Strength (kg/cm ²)	伸长率 Elongation (%)	特性 Characteristic	用途 Uses
品名 Articles							
HDS-80	29~31	8~14	70~80	≥300	≥300	中软质,低粘性 Medium soft,Less-tacky	鞋,包,家具 Shoes,Bags, Furniture
HDS-130	29~31	8~14	120~140	≥300	≥300	硬质,无粘 Hard,Non-tacky	鞋,包,家具 Shoes,Bags, Furniture
HDS-150	29~31	8~14	120~140	≥300	≥300	硬质,无粘 Hard,Non-tacky	鞋,包,家具 Shoes,Bags, Furniture
HDS-300	29~31	8~14	270~330	≥300	≥200	高硬质 Hard type	鞋,包,家具 Shoes,Bags, Furniture
HDS-9050	29~31	8~14	35~45	≥200	≥400	软质,展色性好 Soft,Good pigment dispersion	服装,鞋,包,家具 Garments,Shoes, Bags,Furniture
HDS-9080	29~31	8~14	60~70	≥200	≥300	中软质,展色性好 Medium soft,Good pigment dispersion	鞋,包,家具 Shoes,Bags, Furniture
HDS-30A	29~31	8~14	30~40	≥300	≥400	软质,无粘性 Soft,Non-tacky	服装,鞋,包,家具 Garments,Shoes, Bags,Furniture
HDS-60B	29~31	8~14	60~70	≥300	≥400	中软质,皮膜感强 Medium soft,Strong sense of film	服装,鞋,包,家具 Garments,Shoes, Bags,Furniture
HDS-80A	29~31	8~14	70~90	≥300	≥300	中软质,低粘性,展色性好 Medium soft,Less-tacky, Good pigment dispersion	鞋,包,家具 Shoes,Bags, Furniture
HDS-100A	29~31	8~14	90~110	≥300	≥300	中硬质,无粘性 Medium hard,Non-tacky	鞋,包,家具 Shoes,Bags, Furniture
HDS-100N	29~31	8~14	100~120	≥300	≥300	中硬质,无粘性 Medium hard,Non-tacky	鞋,包,家具 Shoes,Bags, Furniture
HDS-1030	29~31	8~14	35~55	≥200	≥400	软质,耐高温 Soft,Heat resistance	服装,鞋,包,家具 Garments,Shoes, Bags,Furniture
HDS-1050	29~31	8~14	45~55	≥200	≥400	中软质,耐高温 Medium soft,Heat resistance	服装,鞋,包,家具 Garments,Shoes, Bags,Furniture
HDS-1080	29~31	8~14	70~90	≥300	≥300	中软质,耐高温 Medium soft,Heat resistance	鞋,包,家具 Shoes,Bags, Furniture
HDS-1050A	29~31	8~14	45~55	≥300	≥500	中软质,耐高温,展色性好 Medium soft,Heat resistance, Good pigment dispersion	服装,鞋,包,家具 Garments,Shoes, Bags,Furniture
HDS-1080A	29~31	8~14	70~80	≥300	≥400	中软质,耐高温,展色性好 Medium soft,Heat resistance, Good pigment dispersion	鞋,包,家具 Shoes,Bags, Furniture

规格 Specification	固含量 Solid Content(%)	粘度 Viscosity (10000 cps/25°C)	100%模量 100% Modulus (kg/cm ²)	抗张力 Tensile Strength (kg/cm ²)	伸长率 Elongation (%)	特性 Characteristic	用途 Uses
品名 Articles							
HDS-7030D	29~31	8~16	25~35	≥200	≥500	软质,耐高温 Soft,Heat resistance	服装,鞋,包,家具 Garments,Shoes, Bags,Furniture
HDS-7060D	29~31	8~16	55~65	≥300	≥400	中软质,耐高温 Medium soft,Heat resistance	服装,鞋,包,家具 Garments,Shoes, Bags,Furniture
HDS-7080D	29~31	8~16	60~80	≥300	≥300	中软质,耐高温 Medium soft,Heat resistance	鞋,包,家具 Shoes,Bags, Furniture
HDS-30ET	29~31	8~14	30~40	≥300	≥400	软质,耐高温极好 Soft,Excellent heat resistance	服装,鞋,包,家具 Garments,Shoes, Bags,Furniture
HDS-60ET	29~31	8~14	60~70	≥300	≥500	中软质,耐高温极好 Medium soft,Excellent heat resistance	服装,鞋,包,家具 Garments,Shoes, Bags,Furniture
HDS-2015T	29~31	8~14	20~30	≥300	≥600	超软质,耐高温 Super soft,Heat resistance	鞋,包,家具 Shoes,Bags, Furniture
HDS-4015T	29~31	8~14	25~35	≥300	≥600	超软质,高伸长,高回弹 Super soft,High elongation and resilience	服装,鞋,包,家具 Garments,Shoes, Bags,Furniture
HDS-6015T	29~31	8~14	25~35	≥300	≥600	超软质,高伸长,高回弹 Super soft,High elongation and resilience	服装,鞋,包,家具 Garments,Shoes, Bags,Furniture
HDS-4050S	29~31	6~14	40~50	≥300	≥500	软质,高伸长,高回弹 Soft,High elongation and resilience	服装,鞋,包,家具 Garments,Shoes, Bags,Furniture
HDS-2035W	29~31	6~10	25~35	≥200	≥500	透湿防水 Vapor permeability& Water proof	服装 Garments
HDS-2080W	29~31	8~14	75~95	≥300	≥300	透湿防水 Vapor permeability& Water proof	服装 Garments

镜面系列干法面层树脂

DRY PROCESS PU RESIN FOR ENAMEL

规格 Specification	固含量 Solid Content(%)	粘度 Viscosity (10000 cps/25°C)	100%模量 100% Modulus (kg/cm ²)	抗张力 Tensile Strength (kg/cm ²)	伸长率 Elongation (%)	特性 Characteristic	用途 Uses
品名 Articles							
HDS-3080S	29~31	8~14	70~90	≥300	≥300	中软质,展色性好 Medium soft,Good pigment dispersion	鞋,包 Shoes,Bags
HDS-130S	29~31	8~14	130~170	≥300	≥200	中硬质,展色性好 Medium hard,Good pigment dispersion	鞋,包 Shoes,Bags

规格 Specification	固含量 Solid Content(%)	粘度 Viscosity (10000 cps/25°C)	100%模量 100% Modulus (kg/cm ²)	抗张力 Tensile Strength (kg/cm ²)	伸长率 Elongation (%)	特性 Characteristic	用途 Uses
品名 Articles							
HDS-5130S	29~31	8~14	120~160	≥300	≥300	中硬质,展色性好 Medium hard,Good pigment dispersion	鞋,包 Shoes,Bags
HDS-8080S	29~31	8~16	75~95	≥300	≥300	中软质,展色性好,透亮感好 Medium soft,Good pigment dispersion, Good transparency	服装,鞋,包 Garments,Shoes,Bags
HDS-8130S	29~31	8~14	120~140	≥300	≥200	中硬质,展色性好,透亮感好 Medium hard,Good pigment dispersion, Good transparency	鞋,包 Shoes,Bags
HDS-2110	29~31	8~14	130~170	≥300	≥300	中硬质,透亮性好 Medium hard,Excellent transparency	鞋,包 Shoes,Bags

注塑系列干法面层树脂

DRY PROCESS PU RESIN FOR INJECTION

规格 Specification	固含量 Solid Content(%)	粘度 Viscosity (10000 cps/25°C)	100%模量 100% Modulus (kg/cm ²)	抗张力 Tensile Strength (kg/cm ²)	伸长率 Elongation (%)	特性 Characteristic	用途 Uses
品名 Articles							
HDS-1085CP	29~31	8~14	70~90	≥300	≥300	中软质,展色性好,耐溶剂强 Medium soft,Good pigment dispersion, Good solvent resistance	鞋 Shoes
HDS-5080CP	29~31	8~14	90~120	≥300	≥300	中硬质,展色性好 Medium hard,Good pigment dispersion	鞋 Shoes
HDS-3120CP	29~31	8~14	120~150	≥300	≥200	中硬质,展色性好,镜面 Medium hard,Good pigment dispersion,Enamel type	鞋 Shoes
HDS-6030CP	29~31	8~14	25~35	≥200	≥400	软质,展色性好 Soft,Good pigment dispersion	鞋 Shoes
HDS-6050CP	29~31	8~14	45~55	≥200	≥400	中软质,展色性好 Medium soft,Good pigment dispersion	鞋 Shoes

半PU系列干法面层树脂

DRY PROCESS PU RESIN FOR SEMI-PU SYNTHETIC MATERIAL

规格 Specification	固含量 Solid Content (%)	粘度 Viscosity (10000 cps/25°C)	100%模量 100% Modulus (kg/cm ²)	抗张力 Tensile Strength (kg/cm ²)	伸长率 Elongation (%)	特性 Characteristic	用途 Uses
HDS-80B	29~31	8~14	70~90	≥300	≥300	中软质,与PVC粘性好 Medium soft,Good adhesion with PVC	包,家具 Bags,Furniture
HDS-130B	29~31	8~14	130~170	≥300	≥200	中硬质,与PVC粘性好 Medium hard,Good adhesion with PVC	包,家具 Bags,Furniture
HDS-150B	29~31	8~14	130~170	≥300	≥200	中硬质,与PVC粘性好 Medium hard,Good adhesion with PVC	包,家具 Bags,Furniture
HDS-300B	29~31	8~14	300~360	≥300	≥150	高硬质,与PVC粘性好 Super hard,Good adhesion with PVC	包,家具 Bags,Furniture
HDS-8610B	24~26	8~14	100~140	≥300	≥300	中硬质,与PVC粘性好,耐磨性好 Medium hard,Good adhesion with PVC,Good abrasion resistance	包,家具 Bags,Furniture
HDS-4080V	29~31	8~16	65~85	≥300	≥300	中软质,与PVC接着性好 Medium soft,Good adhesion with PVC	包,家具 Bags,Furniture
HDS-2130V	29~31	8~14	130~160	≥300	≥300	中硬质,与PVC接着性好 Medium hard,Good adhesion with PVC	包,家具 Bags,Furniture
HDS-2300V	29~31	8~14	300~360	≥300	≥200	高硬质,与PVC接着性好 Super hard,Good adhesion with PVC	包,家具 Bags,Furniture
HDS-9080V	29~31	8~14	85~105	≥300	≥300	中软质,与PVC接着性好 Medium soft,Good adhesion with PVC	包,家具 Bags,Furniture
HDS-9130V	29~31	8~14	130~170	≥300	≥200	中硬质,与PVC接着性好 Medium hard,Good adhesion with PVC	包,家具 Bags,Furniture
HDS-9200V	29~31	8~16	210~250	≥300	≥200	硬质,与PVC接着性好 Hard,Good adhesion with PVC	包,家具 Bags,Furniture
HDS-9300V	29~31	8~16	270~330	≥300	≥200	高硬质,与PVC接着性好 Super hard,Good adhesion with PVC	包,家具 Bags,Furniture
HDS-7125F	24~26	8~14	130~170	≥300	≥200	中硬质,与PVC接着性好 Medium hard,Good adhesion with PVC	包,家具 Bags,Furniture
HDS-2130VB	29~31	4~8	160~200	≥300	≥200	硬质,与PVC接着性好,耐磨,无黄变 Hard,Good adhesion with PVC, Abrasion resistance,Non-yellowing	包,家具 Bags,Furniture

耐磨耐刮系列干法面层树脂

DRY PROCESS PU RESIN WITH ABRASION AND SCRAPE RESISTANCE

24

规格 Specification	固含量 Solid Content (%)	粘度 Viscosity (10000 cps/25°C)	100%模量 100% Modulus (kg/cm ²)	抗张力 Tensile Strength (kg/cm ²)	伸长率 Elongation (%)	特性 Characteristic	用途 Uses
HDS-1135B	29~31	8~14	40~50	≥200	≥500	软质,清爽,耐磨,高耐温,防爆针 Soft,Slippery,Abrasion and heat resistance,Resistance to needle broken	服装,鞋,包,家具 Garments,Shoes, Bags,Furniture
HDS-1135BS	29~31	8~14	40~50	≥200	≥500	软质,清爽,耐磨,高耐温 Soft,Slippery,Abrasion and heat resistance	服装,鞋,包,家具 Garments,Shoes, Bags,Furniture
HDS-4018B	29~31	8~14	30~40	≥300	≥500	软质,清爽,耐磨,高耐温,防爆针 Soft,Slippery,Abrasion and heat resistance,Resistance to needle broken	服装,鞋,包,家具 Garments,Shoes, Bags,Furniture
HDS-6025B	29~31	8~16	30~40	≥300	≥500	软质,清爽,耐磨,防爆针 Soft,Slippery,Abrasion resistance, Resistance to needle broken	服装,鞋,包,家具 Garments,Shoes, Bags,Furniture
HDS-6025BLV	29~31	1~5	25~35	≥200	≥600	软质,清爽,耐磨,防爆针 Soft,Slippery,Abrasion resistance, Resistance to needle broken	服装,鞋,包,家具 Garments,Shoes, Bags,Furniture
HDS-7015B	29~31	8~16	25~35	≥300	≥700	超软质,清爽,耐磨 Super Soft,Slippery, Abrasion resistance	服装,鞋,包,家具 Garments,Shoes, Bags,Furniture
HDS-5035F	29~31	8~14	40~50	≥300	≥500	软质,耐磨 Soft,Abrasion resistance	服装,鞋,包,家具 Garments,Shoes, Bags,Furniture
HDS-4036B	29~31	8~14	30~40	≥300	≥500	软质,高清爽,高耐磨,高耐温,防爆针 Soft,Excellent slippery, Abrasion and heat resistance,Resistance to needle broken	服装,鞋,包,家具 Garments,Shoes, Bags,Furniture
HDS-4050B	29~31	8~14	40~50	≥300	≥500	中软质,清爽,耐磨,防爆针 Medium soft,Slippery an abrasion resistance,Resistance to needle broken	服装,鞋,包,家具 Garments,Shoes, Bags,Furniture
HDS-7050B	29~31	8~14	45~55	≥300	≥500	中软质,清爽,耐磨 Medium soft,Slippery and abrasion resistance	服装,鞋,包,家具 Garments,Shoes, Bags,Furniture
HDS-860B	29~31	8~14	60~80	≥300	≥300	中软质,高清爽,高耐磨,防爆针 Medium soft,Excellent slippery and abrasion resistance, Resistance to needle broken	服装,鞋,包,家具 Garments,Shoes, Bags,Furniture
HDS-860BLV	34~36	0.8~1.2	65~85	≥200	≥500	中软质,高清爽,高耐磨,防爆针,低粘 Medium soft,Excellent slippery and abrasion resistance,Resistance to needle broken,Low viscosity	服装,鞋,包,家具 Garments,Shoes, Bags,Furniture
HDS-4130B	24~26	8~16	90~120	≥300	≥300	中硬质,清爽性,通透性好 Medium hard,Good slippery and transparency	标签,包装 Label,Packing
HDS-5255B	24~26	8~14	55~65	≥300	≥400	中软质,清爽性好,通透性好 Medium soft,Good slippery and transparency	标签,包装 Label,Packing
HDS-3250B	24~26	8~14	290~350	≥300	≥150	高硬质,清爽性,通透性好 Super hard,Excellent slippery and transparency	标签,包装 Label,Packing
HDS-6200B	19~21	8~16	290~350	≥300	≥150	高硬质,高清爽,高透明 Super hard,High slippery and transparency	标签,包装 Label,Packing

耐水解系列干法面层树脂

DRY PROCESS PU RESIN WITH HYDROLYSIS-RESISTANCE

规格 Specification	固含量 Solid Content(%)	粘度 Viscosity (10000 cps/25°C)	100%模量 100% Modulus (kg/cm ²)	抗张力 Tensile Strength (kg/cm ²)	伸长率 Elongation (%)	特性 Characteristic	用途 Uses
品名 Articles							
HDS-305F	29~31	8~14	35~45	≥200	≥600	软质,耐水解,湿涩感 Soft, Hydrolysis resistance, Wet touch	家具 Furniture
HDS-8305F	29~31	8~14	35~45	≥200	≥600	软质,耐水解,湿涩感 Soft, Hydrolysis resistance, Wet touch	家具 Furniture
HDS-7037F	29~31	8~14	40~50	≥300	≥600	软质,高耐水解 Soft, Excellent Hydrolysis resistance	家具 Furniture
HDS-7037FB	29~31	8~16	30~40	≥300	≥600	软质,高耐水解,耐磨耐刮 Soft, Excellent Hydrolysis resistance Abrasion resistance	家具 Furniture
HDS-6035B	29~31	8~14	30~40	≥300	≥400	软质,耐水解 Soft, Hydrolysis resistance	鞋,家具 Shoes,Furniture
HDS-860HPB	29~31	8~14	55~65	≥300	≥400	中软质,耐水解,清爽,耐磨 Medium soft,Hydrolysis resistance,Slippery,Abrasion resistance	鞋,家具 Shoes,Furniture
HDS-5085HCP	29~31	8~14	55~65	≥300	≥400	中软质,耐水解性好 Medium soft,Good hydrolysis resistance	鞋,家具 Shoes,Furniture
HDS-60HB	29~31	8~14	50~60	≥300	≥500	中软质,耐水解性好,耐低温屈挠 Medium soft,Good Hydrolysis resistance,Low temperature flexibility	鞋,家具 Shoes,Furniture
HDS-860HB	29~31	8~14	50~60	≥300	≥500	中软质,耐水解性好,耐低温屈挠 Medium soft,Good Hydrolysis resistance,Low temperature flexibility	鞋,家具 Shoes,Furniture
HDS-100H	29~31	8~14	90~110	≥300	≥400	中硬质,耐水解性好 Medium hard,Hydrolysis resistance	鞋,家具 Shoes,Furniture
HDS-2050HT	29~31	8~14	45~55	≥300	≥500	中软质,耐水解好,耐高温 Medium soft,Hydrolysis and heat resistance	鞋,家具 Shoes,Furniture
HDS-6020HB	29~31	8~14	20~30	≥300	≥500	软质,耐水解性,耐磨性好,湿蜡感 Soft,Good hydrolysis and abrasion resistance,Wet wax feeling	鞋,包装 Shoes,Packing
HDS-1050HB	29~31	8~14	45~55	≥300	≥500	中软质,耐水解性好,耐磨 Medium soft, Good hydrolysis resistance, Abrasion resistance	鞋,家具,包装 Shoes,Furniture,Packing
HDS-9310HB	29~31	8~14	70~90	≥300	≥300	中软质,耐水解性好,清爽,耐磨 Medium soft,Good hydrolysis resistance,Slippery,Abrasion resistance	鞋,家具 Shoes,Furniture

耐黄变及无黄变系列干法面层树脂

NON-YELLOWING AND YELLOWING-RESISTANCE DRY PROCESS PU RESIN

规格 Specification	固含量 Solid Content(%)	粘度 Viscosity (10000 cps/25°C)	100%模量 100% Modulus (kg/cm ²)	抗张力 Tensile Strength (kg/cm ²)	伸长率 Elongation (%)	特性 Characteristic	用途 Uses
品名 Articles							
HDS-8030NY	29~31	8~14	30~40	≥300	≥500	软质,耐黄变 Soft,yellowing Resistance	服装,鞋,包,家具 Garments,Shoes, Bags,Furniture
HDS-8050NY	29~31	8~14	50~60	≥300	≥400	中软质,耐黄变 Medium soft,yellowing Resistance	服装,鞋,包,家具 Garments,Shoes, Bags,Furniture
HDS-80NY	29~31	8~14	65~85	≥300	≥300	中软质,耐黄变 Medium soft,yellowing Resistance	鞋,包,包装 Shoes,Bags, Packing
HDS-130NY	29~31	8~14	130~150	≥300	≥300	中硬质,镜面,耐黄变 Medium hard,yellowing Resistance	鞋,包,包装 Shoes,Bags, Packing
HDS-30Y	29~31	8~14	30~40	≥200	≥400	软质,无黄变 Soft,Non-yellowing	鞋,包,包装 Shoes,Bags, Packing
HDS-50Y	29~31	8~14	60~80	≥200	≥300	中软质,无黄变 Medium soft,Non-yellowing	鞋,包,包装 Shoes,Bags, Packing
HDS-60Y	29~31	8~14	60~80	≥200	≥300	中软质,无黄变 Medium soft,Non-yellowing	鞋,包,包装 Shoes,Bags, Packing
HDS-6060Y	24~26	5~10	70~80	≥300	≥400	中软质,无黄变 Medium soft,Non-yellowing	鞋,包,包装 Shoes,Bags, Packing
HDS-80Y	29~31	8~14	60~80	≥200	≥300	中软质,无黄变 Medium soft,Non-yellowing	鞋,包,包装 Shoes,Bags, Packing
HDS-110Y	29~31	8~14	80~100	≥300	≥300	中硬质,镜面,无黄变 Medium hard,Enamel type, Non-yellowing	鞋,包,球,包装 Shoes,Bags,Ball, Packing
HDS-130Y	29~31	8~14	130~150	≥300	≥200	中硬质,镜面,无黄变 Medium hard,Enamel type, Non-yellowing	鞋,包,球,包装 Shoes,Bags,Ball, Packing
HDS-220YD	24~26	1.5~3	220~260	≥200	≥200	高硬质,镜面,无黄变 Hard,Non-yellowing	鞋,包,球,包装 Shoes,Bags,Ball, Packing
HDS-1005YB	27~29	8~14	55~65	≥300	≥400	中软质,耐磨,无黄变 Medium soft,Abrasion resistance,Non-yellowing	鞋,包,包装 Shoes,Bags, Packing
HDS-3030YB	29~31	8~14	40~50	≥300	≥400	软质,耐磨,无黄变 Soft,Abrasion resistance, Non-yellowing	鞋,包,包装 Shoes,Bags, Packing
HDS-50HY	29~31	8~14	40~60	≥300	≥500	软质,耐水解,无黄变 Soft,Hydrolysis resistance, Non-yellowing	鞋 Shoes
HDS-7030HY	29~31	8~14	25~35	≥300	≥600	软质,耐水解,无黄变 Soft,Hydrolysis resistance, Non-yellowing	家具,包装 Furniture,Packing

规格 Specification	固含量 Solid Content (%)	粘度 Viscosity (10000 cps/25°C)	100%模量 100% Modulus (kg/cm ²)	抗张力 Tensile Strength (kg/cm ²)	伸长率 Elongation (%)	特性 Characteristic	用途 Uses
品名 Articles							
HDS-130HY	24~26	8~14	90~120	≥300	≥300	硬质,耐水解,无黄变 Hard,Hydrolysis resistance, Non-yellowing	鞋 Shoes
HDS-30HYB	24~26	2~6	30~40	≥200	≥400	软质,耐水解,耐酒精,无黄变 Soft,Hydrolysis and Alcohol resistance,Non-yellowing	家具,包装 Furniture,Packing
HDS-50HYB	24~26	2~4	50~60	≥300	≥300	中软质,耐水解,耐酒精,无黄变 Medium soft,Hydrolysis and alcohol resistance,Non-yellowing	家具,包装 Furniture,Packing
HDS-60HYB	24~26	2~4	70~90	≥300	≥300	中软质,耐水解,耐酒精,无黄变 Medium soft,Hydrolysis and alcohol resistance,Non-yellowing	家具,包装 Furniture,Packing
HDS-860HYB	24~26	2~4	70~90	≥300	≥300	中软质,耐水解,耐酒精,无黄变 Medium soft,Hydrolysis and alcohol resistance,Non-yellowing	家具,包装 Furniture,Packing
HDS-80HYB	24~26	2~4	70~90	≥300	≥300	中软质,耐水解,耐酒精,无黄变 Medium soft,Hydrolysis and alcohol resistance,Non-yellowing	家具,包装 Furniture,Packing
HDS-120HYB	24~26	1.5~3	120~140	≥300	≥300	硬质,与PVC粘性好,耐酒精,无黄变 Hard,Good adhesion with PVC, Alcohol resistance,Non-yellowing,	家具,包装 Furniture,Packing
HDS-6100HYB	24~26	4~6	115~135	≥200	≥300	硬质,耐水解,无黄变,耐磨 Hard,Hydrolysis resistance, Non-yellowing,abrasion resistance	鞋,包,包装 Shoes,Bags,Packing
HDS-7360HYB	29~31	8~14	45~55	≥300	≥500	软质,耐水解,耐磨,无黄变 Soft,Hydrolysis resistance, Abrasion resistance,Non-yellowing	家具,包装 Furniture,Packing

聚碳酸酯型座椅革系列干法面层树脂

PCD -TYPE DRY PROCESS PU RESIN FOR CAR SEAT SYNTHETIC MATERIAL

规格 Specification	固含量 Solid Content (%)	粘度 Viscosity (10000 cps/25°C)	100%模量 100% Modulus (kg/cm ²)	抗张力 Tensile Strength (kg/cm ²)	伸长率 Elongation (%)	特性 Characteristic	用途 Uses
品名 Articles							
HDS-7038F	24~26	8~14	30~40	≥300	≥300	软质,耐老化,耐磨 Soft, Ageing resistance, Abrasion resistance	家具,汽车内饰 Furniture, Automotive trim
HDS-7038FT	24~26	6~14	35~45	≥300	≥300	软质,耐老化,耐磨,耐高温 Soft, Ageing resistance, Abrasion resistance, Heat resistance	家具,汽车内饰 Furniture, Automotive trim
HDS-3010F	29~31	8~14	35~45	≥300	≥300	中软质,耐老化,耐磨 Medium soft, Ageing resistance, Abrasion resistance	家具,汽车内饰 Furniture, Automotive trim
HDS-9010F	29~31	8~14	85~105	≥300	≥300	中硬质,耐老化,耐磨 Medium hard, Ageing resistance, Abrasion resistance	家具,汽车内饰 Furniture, Automotive trim
HDS-5000N	19~21	3~6	45~65	≥300	≥300	软质,耐磨,耐老化 Soft, Abrasion and aging resistance	汽车内饰 Automotive trim

规格 Specification	固含量 Solid Content (%)	粘度 Viscosity (10000 cps/25°C)	100%模量 100% Modulus (kg/cm ²)	抗张力 Tensile Strength (kg/cm ²)	伸长率 Elongation (%)	特性 Characteristic	用途 Uses
品名 Articles							
HDS-5025NY	24~26	2~5	30~40	≥250	≥300	软质,无黄变,耐老化,耐曲挠 Soft, Non-yellowing, Flexibility and aging resistance	汽车内饰 Automotive trim
HDS-5035NY	29~31	2~5	40~60	≥250	≥300	软质,无黄变,耐老化 Soft, Non-yellowing, Aging resistance	汽车内饰 Automotive trim
HDS-5035YC	29~31	2~6	40~50	≥300	≥300	软质,无黄变,耐磨,耐老化 Soft, Non-yellowing, Abrasion and aging resistance	汽车内饰 Automotive trim
HDS-5035HNY	29~31	2~5	40~60	≥250	≥300	软质,耐水解性好,无黄变,耐老化 Soft, Good hydrolysis resistance Non-yellowing, Aging resistance	汽车内饰 Automotive trim

干法底料聚氨酯树脂 DRY ADHESIVE RESIN

常规底料树脂

GENERAL TYPE ADHESIVE RESIN

规格 Specification	固含量 Solid Content (%)	粘度 Viscosity (10000 cps/25°C)	100%模量 100% Modulus (kg/cm ²)	抗张力 Tensile Strength (kg/cm ²)	伸长率 Elongation (%)	特性 Characteristic	用途 Uses
品名 Articles							
HDA-15	34~36	8~14	20~30	≥200	≥700	超软质,常规型 Super soft, General type	服装,包,家具 Garments, Bags, Furniture
HDA-25	34~36	8~14	20~30	≥200	≥700	软质,常规型 Soft, General type	服装,包,家具 Garments, Bags, Furniture
HDA-25NT	34~36	8~14	20~30	≥200	≥800	软质,常规型 Soft, General type	服装,包,家具 Garments, Bags, Furniture
HDA-50	44~46	8~14	40~50	≥300	≥600	中软质,常规型 Medium soft, General type	鞋,包,家具 Shoes, Bags, Furniture
HDA-1503	49~51	8~14	25~35	≥100	≥700	高固,粘性好 High solid, Good adhesion	服装,鞋,包,家具 Garments, Shoes, Bags, Furniture
HDA-3358H	34~36	8~14	10~20	≥200	≥600	超软质,常规型 Super soft, General type	服装,包,家具 Garments, Bags, Furniture
HDA-3510H	49~51	8~14	15~25	≥100	≥800	软质,常规型 Soft, General type	服装,包,家具 Garments, Bags, Furniture

规格 Specification	固含量 Solid Content (%)	粘度 Viscosity (10000 cps/25°C)	100%模量 100% Modulus (kg/cm ²)	抗张力 Tensile Strength (kg/cm ²)	伸长率 Elongation (%)	特性 Characteristic	用途 Uses
品名 Articles							
HDA-3530D	34~36	8~14	35~45	≥300	≥600	粘结性优秀,耐溶剂性好 Good adhesion, Solvent resistance	鞋,包,家具 Shoes, Bags, Furniture
HDA-4030	39~41	8~14	30~40	≥300	≥600	粘结性优秀,耐溶剂性好 Good adhesion, Solvent resistance	鞋,包,家具 Shoes, Bags, Furniture
HDA-4515	44~46	8~14	5~15	≥50	≥800	与TPU粘结性好,初粘性好 Good adhesion with TPU, Good initial adhesion	服装,鞋,包,家具 Garments, Shoes, Bags, Furniture
HDA-5040	49~51	8~14	30~40	≥100	≥300	高固,粘结性优秀 High solid, Good adhesion	服装,鞋,包,家具 Garments, Shoes, Bags, Furniture
HDA-5040D	49~51	8~14	30~40	≥100	≥300	高固,粘结性优秀 High solid, Good adhesion	服装,鞋,包,家具 Garments, Shoes, Bags, Furniture
HDA-3508HLV	49~51	1.5~3.0	10~20	≥50	≥800	高固低粘,超软质 High solid, Low viscosity, Super soft	服装,包,家具 Garments, Bags, Furniture
HDA-5040LV	49~51	1~2	25~35	≥50	≥500	高固,粘结性优秀 High solid, Good adhesion	服装,鞋,包,家具 Garments, Shoes, Bags, Furniture
HDA-5080LV	49~51	2~3	75~95	≥150	≥300	高固,粘结性优秀 High solid, Good adhesion	服装,鞋,包,家具 Garments, Shoes, Bags, Furniture
HDA-5040FD	49~51	8~14	35~45	≥100	≥300	高固,粘结性优秀 High solid, Good adhesion	服装,鞋,包,家具 Garments, Shoes, Bags, Furniture
HDA-5040ND	49~51	8~14	25~35	≥100	≥700	高固,粘结性优秀 High solid, Good adhesion	服装,鞋,包,家具 Garments, Shoes, Bags, Furniture
HDA-5040NY	49~51	8~14	30~40	≥100	≥500	高固,耐黄变 High solid, Yellowing resistance	家具 Furniture
HDA-6540	49~51	8~14	30~40	≥100	≥600	高固,耐水压高,粘结性优秀 High solid, High water pressure resistance, Good adhesion	雨衣 Rain coat

耐水解底料树脂 HYDROLYSIS RESISTANCE ADHESIVE RESIN

规格 Specification	固含量 Solid Content (%)	粘度 Viscosity (10000 cps/25°C)	100%模量 100% Modulus (kg/cm ²)	抗张力 Tensile Strength (kg/cm ²)	伸长率 Elongation (%)	特性 Characteristic	用途 Uses
品名 Articles							
HDA-3025H	29~31	8~14	15~25	≥300	≥700	软质,耐水解性好 Soft, Good hydrolysis resistance	鞋,家具 Shoes, Furniture
HDA-8410HH	39~41	8~14	10~20	≥50	≥800	超软质,耐水解性好,细折痕 Super soft, Good hydrolysis resistance, Fine crease	家具 Furniture

规格 Specification	固含量 Solid Content (%)	粘度 Viscosity (10000 cps/25°C)	100%模量 100% Modulus (kg/cm ²)	抗张力 Tensile Strength (kg/cm ²)	伸长率 Elongation (%)	特性 Characteristic	用途 Uses
品名 Articles							
HDA-4009H	39~41	8~14	15~25	≥100	≥800	超软质,耐水解性好,细折痕,耐溶剂 Super soft, Good hydrolysis resistance, Fine crease, solvent resistance	鞋,家具 Shoes, Furniture
HDA-4030H	39~41	8~14	35~45	≥300	≥600	耐水解,耐溶剂,粘结性优秀 Hydrolysis resistance, Solvent resistance, Good adhesion	鞋,家具 Shoes, Furniture
HDA-4035H	39~41	8~14	30~40	≥300	≥600	耐水解性好,耐溶剂,粘结性优秀 Good hydrolysis resistance, Solvent resistance, Good adhesion	鞋,家具 Shoes, Furniture
HDA-4035HLV	39~41	2~6	30~40	≥200	≥600	耐水解性好,耐溶剂,粘结性优秀 Good hydrolysis resistance, Solvent resistance, Good adhesion	鞋,家具 Shoes, Furniture
HDA-4508H	44~46	8~14	20~30	≥100	≥700	超软质,耐水解性好,细折痕,耐溶剂 Super soft, Good hydrolysis resistance, Fine crease, Excellent solvent resistance	鞋,家具 Shoes, Furniture
HDA-4515H	44~46	8~14	10~20	≥50	≥800	软质,耐水解 Soft, Hydrolysis resistance	鞋,家具 Shoes, Furniture
HDA-4025H	39~41	8~14	25~35	≥300	≥600	软质,耐水解性好 Soft, Good hydrolysis resistance	鞋,家具 Shoes, Furniture
HDA-4015HLV	39~41	1~6	10~20	≥100	≥700	超软质,耐水解性好 Super soft, Good hydrolysis resistance	鞋,家具 Shoes, Furniture
HDA-4530HLV	44~46	6~8	30~40	≥200	≥800	软质,耐水解性好 Soft, Good hydrolysis resistance	鞋,家具 Shoes, Furniture
HDA-7510H	49~51	8~14	20~30	≥100	≥700	软质,耐水解性好 Soft, Good hydrolysis resistance	鞋,家具 Shoes, Furniture
HDA-8506H	49~51	8~14	10~20	≥50	≥800	超软质,耐水解性好,细折痕 Super soft, Good hydrolysis resistance, Fine crease	包 Bags

PVC底料树脂 ADHESIVE RESIN FOR PVC

规格 Specification	固含量 Solid Content (%)	粘度 Viscosity (10000 cps/25°C)	100%模量 100% Modulus (kg/cm ²)	抗张力 Tensile Strength (kg/cm ²)	伸长率 Elongation (%)	特性 Characteristic	用途 Uses
品名 Articles							
HDA-55	44~46	8~14	45~55	≥300	≥500	与PVC粘结优秀 Good adhesion with PVC	包,家具 Bags, Furniture
HDA-2455B	44~46	8~14	50~60	≥300	≥500	与PVC粘结优秀 Good adhesion with PVC	包,家具 Bags, Furniture
HDA-2455BNF	44~46	8~14	50~60	≥300	≥500	与PVC粘结优秀 Good adhesion with PVC	包,家具 Bags, Furniture

规格 Specification	固含量 Solid Content(%)	粘度 Viscosity (10000 cps/25°C)	100%模量 100% Modulus (kg/cm ²)	抗张力 Tensile Strength (kg/cm ²)	伸长率 Elongation (%)	特性 Characteristic	用途 Uses
品名 Articles							
HDA-830	44~46	8~14	40~50	≥200	≥500	与PVC粘接优秀 Good adhesion with PVC	包,家具 Bags,Furniture
HDA-4530VHB	44~46	8~14	30~40	≥300	≥500	与PVC粘接优秀,丛林测试4周 Good adhesion with PVC, 4 weeks at 70°C and 95% RH	包,家具 Bags,Furniture
HDA-5055B	48~52	8~14	45~55	≥100	≥500	与PVC粘接优秀 Good adhesion with PVC	包,家具 Bags,Furniture

二液型底料树脂树脂

TWO COMPONENTS ADAESIVE RESIN

规格 Specification	固含量 Solid Content(%)	粘度 Viscosity (10000 cps/25°C)	100%模量 100% Modulus (kg/cm ²)	抗张力 Tensile Strength (kg/cm ²)	伸长率 Elongation (%)	特性 Characteristic	用途 Uses
品名 Articles							
HDBA-3515	34~36	8~14	15~25	≥50	≥400	超软质,与TPU粘接性好 Super soft, Good adhesio with TPU	鞋,包 Shoes,Bags
HDBA-4505	44~46	8~14	10~20	≥50	≥400	超软质,与尼龙、PVC粘接性优秀 Super soft, Good adhesion with PVC and nylon	服装,鞋,家具 Garments,Shoes, Furniture
HDBA-2502	49~51	8~14	30~40	≥200	≥400	软质,粘接性优秀 Soft,Good adhesion	服装,鞋,家具 Garments,Shoes, Furniture
HDBA-9515	48~52	6~12	35~45	≥50	≥300	软质,与尼龙、PVC粘接性优秀 Soft,Good adhesion with PVC and nylon	服装,鞋,家具 Garments,Shoes, Furniture
HDBA-6020	59~61	4~8	25~35	≥200	≥500	软质,粘接性优秀 Soft,Good adhesion	二脚皮 Split synthetic material
HDBA-6025	58~62	5~10	20~30	≥200	≥300	软质,粘接性优秀 Soft,Good adhesion	二脚皮 Split synthetic material
HDBA-6515	62~68	8~16	25~35	≥50	≥200	与尼龙、PVC粘接性优秀 Good adhesion with PVC and nylon	服装,鞋,家具 Garments,Shoes, Furniture
HDBA-7015	62~68	8~16	30~40	≥100	≥300	与尼龙、PVC粘接性优秀 Good adhesion with PVC and nylon	服装,鞋,家具 Garments,Shoes, Furniture
HDBA-1165	62~68	8~16	80~100	≥150	≥200	硬质,与尼龙、PVC粘接性优秀 Hard,Good adhesion with PVC and nylon	家具 Furniture
HDBA-6509	62~66	8~14	15~25	≥50	≥200	超软质,回弹好 Super soft,Good resilience	服装,鞋,家具 Garments,Shoes, Furniture
HDBA-7009	66~70	8~16	5~15	≥10	≥300	超软质,回弹好 Super soft,Good resilience	服装,鞋,家具 Garments,Shoes, Packing

规格 Specification	固含量 Solid Content(%)	粘度 Viscosity (10000 cps/25°C)	100%模量 100% Modulus (kg/cm ²)	抗张力 Tensile Strength (kg/cm ²)	伸长率 Elongation (%)	特性 Characteristic	用途 Uses
品名 Articles							
HDBA-7506	72~76	8~14	5~15	≥10	≥300	超软质,回弹好 Super soft,Good resilience	服装,鞋,家具 Garments,Shoears, Packing
HDBA-2602P	59~61	4~6	20~30	≥100	≥400	粘接性优秀,耐老化 Good adhesion,Ageing resistance	汽车内饰 Automotive trim
HDBA-4652NT	63~67	8~14	25~35	≥100	≥300	软质,粘接性优秀 Soft,Good adhesion	服装,鞋,家具 Garments,Shoes, Furniture
HDBA-9652NT	62~68	8~16	10~20	≥50	≥200	软质,粘接性优秀 Soft,Good adhesion	服装,鞋,家具 Garments,Shoears, Packing
HDBA-6022H	58~62	8~14	15~25	≥200	≥300	软质,粘接性优秀 Soft,Good adhesion	汽车内饰 Automotive trim
HDBA-7530H	54~56	1~5	35~55	≥200	≥400	软质,耐水解性好 Soft,Good hydrolysis resistance	汽车内饰 Automotive trim

直接涂层聚氨酯树脂

PU RESIN FOR DIRECT COATING

规格 Specification	固含量 Solid Content(%)	粘度 Viscosity (10000 cps/25°C)	100%模量 100% Modulus (kg/cm ²)	抗张力 Tensile Strength (kg/cm ²)	伸长率 Elongation (%)	特性 Characteristic	用途 Uses
品名 Articles							
HDU-30T	29~31	8~14	25~35	≥300	≥600	软质,常规 Soft,General type	帐篷,箱包 Tents,Bags
HDU-50T	29~31	8~14	35~45	≥300	≥500	中软质,常规型 Medium soft,General type	箱包 Bags
HDU-150	29~31	8~14	120~140	≥300	≥300	中硬质,常规型 Medium hard,General type	箱包 Bags
HDU-300	29~31	8~14	270~330	≥300	≥200	高硬质,常规型 Hard,General type	帐篷,箱包 Tents,Bags
HDU-5010	49~51	8~14	10~20	≥100	≥600	高固,高耐水压 High solid,High water pressure resistance	帐篷,箱包 Tents,Bags
HDU-5020	49~51	8~14	15~25	≥100	≥800	高固,高耐水压 High solid,High water pressure resistance	帐篷,箱包 Tents,Bags
HDU-5040	49~51	8~14	30~40	≥100	≥300	高固,高耐水压 High solid,High water pressure resistance	帐篷,箱包 Tents,Bags

规格 Specification	固含量 Solid Content(%)	粘度 Viscosity (10000 cps/25°C)	100%模量 100% Modulus (kg/cm ²)	抗张力 Tensile Strength (kg/cm ²)	伸长率 Elongation (%)	特性 Characteristic	用途 Uses
HDBU-6515	62~68	8~16	25~35	≥50	≥200	超软质,二液型,高耐水压 Super soft,Two components, High water pressure resistance	帐篷,箱包 Tents,Bags
HDBU-2035W	34-36	8~14	30~40	≥100	≥300	防水透湿 Vapor permeability & Waterproof	面涂,服装 Topcoat,Garments
HDBU-4510W	44-46	6~12	20~30	≥100	≥200	防水透湿 Vapor permeability & Waterproof	底涂,服装 Primer,Garments

环境友好型聚氨酯树脂 ENVIRONMENTAL FRIENDLY RESIN

无溶剂CPU树脂 SOLVENT FREE COATING POLYURETHANE PREPOLYMER

规格 Specification	固含量 Solid Content(%)	粘度 Viscosity (cps/25°C)	特性 Characteristic	用途 Uses
HDPM-6002A HDPM-6002B	100	600~1000 1000~1500	发泡底层,超软质,丰满,肉感强,耐水解 Primer foam,Super soft,Good fullness, Hydrolysis resistance	服装,鞋,家具 Garments,Shoes, Furniture
HDPM-3004A HDPM-3004B	100	1000~1500 1000~1500	发泡底层,软质,丰满,肉感强,耐水解 Primer foam,Soft,Good fullness, Hydrolysis resistance	服装,鞋,家具 Garments,Shoes, Furniture
HDPM-3005A HDPM-3005B	100	1000~1500 1000~1500	发泡底层,中软质,高回弹,耐水解 Primer foam,Medium soft,High resilience, Hydrolysis resistance	鞋,家具 Shoes,Furniture
HDPM-3008A HDPM-3008B	100	1000~1500 1000~1500	低泡底层,中软质,无折痕,弹性好,剥离强度高,耐水解 Low primer foam,Medium soft,Non-crease,Good elastic, High peeling strength,Hydrolysis resistance	鞋,家具 Shoes,Furniture
HDPM-5005A HDPM-5005B	100	1000~2000 1000~1500	发泡底层,中软质,细折痕,高剥离,高耐磨,耐刮,耐水解 Primer foam,Medium soft,Fine creases,High peeling strength, High abrasion and scrape resistance,Hydrolysis resistance	鞋,家具 Shoes,Furniture
HDPM-5002A HDPM-5002B	100	1000~2000 1000~1500	面层,中软质,无黄变,高透,高亮,耐水解 Medium soft skin,Non-yellowing,High transparency, High brightness,Hydrolysis resistance	球,鞋,家具 Balls,Shoes,Furniture
HDPM-5004A HDPM-5004B	100	1000~2000 1000~1500	面层,中软质,高耐磨,耐刮,耐水解 Medium soft skin,High abrasion and scrape resistance, Hydrolysis resistance	鞋,家具 Shoes,Furniture
HDPM-6008A HDPM-6008B	100	1000~2000 3000~6000	面层,中软质,高耐磨,色分散好,耐水解 Medium soft skin,High abrasion resistance,Good color spreading,Hydrolysis resistance	鞋,家具 Shoes,Furniture
HDPM-6003A HDPM-6003B	100	1000~1500 5000~8000	发泡底层,软质,高回弹,耐水解 Primer foam,Medium soft,High resilience, Hydrolysis resistance	服装,鞋,家具 Garments,Shoes, Furniture
HDPM-8003A HDPM-8003B	100	1000~1500 5000~8000	发泡底层,软质,高回弹,耐水解 Primer foam,Medium soft,High resilience, Hydrolysis resistance	鞋,家具 Shoes,Furniture

规格 Specification	固含量 Solid Content(%)	粘度 Viscosity (cps/25°C)	特性 Characteristic	用途 Uses
HDPM-8004A HDPM-8004B	100	500~1000 10000~20000	发泡底层,软质,高回弹,耐老化 Primer foam,Medium soft,High resilience, Ageing resistance	汽车内饰 Automotive trim
HDPM-8005A HDPM-8005B	100	1000~1500 5000~8000	发泡底层,中软质,高回弹,耐水解 Primer foam,Medium soft,High resilience, Hydrolysis resistance	鞋,家具 Shoes,Furniture
HDPM-8006A HDPM-8006B	100	1000~1500 5000~8000	发泡底层,中软质,高回弹,耐水解 Primer foam,Medium soft,High resilience, Hydrolysis resistance	二脚皮 Split synthetic material

高固含量聚氨酯树脂 HIGH SOLID CONTENT PU RESIN

规格 Specification	固含量 Solid Content(%)	100%模量 100%Modulus (kg/cm ²)	抗张力 Tensile Strength (kg/cm ²)	伸长率 Elongation(%)	特性 Characteristic	用途 Uses
HDPS-1020	≥98	10~20	≥100	≥800	软质,耐水解,耐寒 Soft,Hydrolysis resistance,Cold resistance	鞋,包,家具 Shoes,Bags, Furniture
HDPS-9025	≥90	30~40	≥200	≥600	中软质,耐水解,高回弹,耐磨耐刮 Medium soft,Hydrolysis resistance,High resilience, Abrasion and scrape resistance	鞋,包,家具 Shoes,Bags, Furniture
HDPS-1080	≥90	70~90	≥200	≥400	中硬质,耐水解,高回弹,耐磨耐刮 Medium hard,Hydrolysis resistance,High resilience, Abrasion and scrape resistance	鞋,包,家具 Shoes,Bags, Furniture

反应型聚氨酯热熔胶 POLYURETHANE REACTIVE Hot-Melt ADHESIVE

规格 Specification	固含量 Solid Content(%)	粘度 Viscosity (cps/100°C)	特性 Characteristic	用途 Uses
HDPUR-001	100	5000~8000	软质,粘接力优秀 Soft,Good adhesion	服装 Garments
HDPUR-002	100	15000~20000	粘接力优秀,耐老化 Good adhesion,Ageing resistance	服装 Garments

水性聚氨酯树脂 WATERBORNE POLYURETHANE

规格 Specification	类型 Type	外观 Appearance	固含量(%) Solid Content(%)	PH值 PH value	100%模量 100% Modulus (kg/cm ²)	抗张力 Tensile Strength (kg/cm ²)	伸长率 Elongation (%)	描述 Description
HDS-PUD4020H	芳香族 Aromatic	乳白 Milky	39~41	6~8	15~25	≥50	≥500	超软质,耐水解,耐寒。用于合成革面层(可用作无溶剂聚氨酯面层) Super soft,Hydrolysis resistance,Cold resistance. Surface layer for synthetic material(especially for non-solvent PU)
HDS-PUD4020HY	脂肪族 Aliphatic	乳白 Milky	39~41	6~8	15~25	≥50	≥500	超软质,耐水解,耐寒,非黄变。用于合成革面层(可用作无溶剂聚氨酯面层) Super soft,Hydrolysis resistance,Cold resistance,Non-yellowing. Surface layer for synthetic material(especially for non-solvent PU)
HDS-PUD4030HY	脂肪族 Aliphatic	乳白 Milky	39~41	6~8	30~40	≥200	≥400	软质,耐水解,非黄变。用于合成革面层(可用作无溶剂聚氨酯面层) Soft,Hydrolysis resistance,Non-yellowing. Surface layer for synthetic material(especially for non-solvent PU)
HDS-PUD4070HY	脂肪族 Aliphatic	乳白 Milky	39~41	6~8	60~80	≥150	≥300	中软质,耐水解,非黄变。用于合成革面层(可用作无溶剂聚氨酯面层) Medium soft,Hydrolysis resistance,Non-yellowing. Surface layer for synthetic material(especially for non-solvent PU)
HDS-PUD4100HY	脂肪族 Aliphatic	乳白 Milky	39~41	6~8	90~110	≥150	≥200	中硬质,耐水解,非黄变。用于合成革面层(可用作无溶剂聚氨酯面层) Medium hard,Hydrolysis resistance,Non-yellowing. Surface layer for synthetic material(especially for non-solvent PU)

特殊加工用聚氨酯树脂 PU RESIN FOR SPECIAL PROCESSING

规格 Specification	固含量 Solid Content(%)	粘度 Viscosity (10000 cps/25°C)	100%模量 100% Modulus (kg/cm ²)	抗张力 Tensile Strength (kg/cm ²)	伸长率 Elongation (%)	特性 Characteristic	用途 Uses
HDW-110	34~36	8~14	100~120	≥300	≥300	消光 Flattening	表面处理剂 Surface-treatment agent
HDW-280	34~36	8~14	220~260	≥300	≥300	增光 Lustre-enhancing	表面处理剂 Surface-treatment agent
HDW-280LV	34~36	1~2	170~230	≥300	≥200	增光 Lustre-enhancing	表面处理剂 Surface-treatment agent
HDW-35MLV	29~31	4~12	35~45	≥300	≥600	黑度好 Deep blackness	牛巴色浆用 For nubuck color paste
HDW-5050T	49~51	4~8	45~55	≥200	≥500	色分散性,展色性好 Good pigment dispersion, Good Color spreading property	色浆用 For color paste
HDS-8010HYP	29~31	2~6	5~15	≥100	≥800	软质,耐水解无黄变,黑度好 Soft,Hydrolysis resistance, Non-yellowing,Deep blackness	表面处理剂 Surface-treatment agent
HDS-1130YP	24~26	2~6	30~40	≥300	≥500	软质,无黄变,弱溶剂 Soft,Non-yellowing, Weak solvent	表面处理剂 Surface-treatment agent
HDS-1130YPLV	24~26	0.6~1.2	20~30	≥200	≥500	软质,无黄变,弱溶剂,低粘 Soft,Non-yellowing,Weak solvent,Low viscosity	表面处理剂 Surface-treatment agent
HDS-2030YP	29~31	2~6	35~45	≥300	≥600	软质,无黄变,弱溶剂 Soft,Non-yellowing,Weak solvent	表面处理剂 Surface-treatment agent
HDS-2030YPLV	29~31	1~5	30~40	≥100	≥500	软质,无黄变,弱溶剂,低粘 Soft,Non-yellowing,Weak solvent, Low viscosity	表面处理剂 Surface-treatment agent
HDS-1180YP	24~26	2~6	90~130	≥200	≥200	中软质,无黄变,弱溶剂 Medium soft,Non-yellowing, Weak solvent	表面处理剂 Surface-treatment agent
HDS-300YP	24~26	2~6	290~360	≥300	≥150	高硬质,弱溶剂,无黄变 Super hard,Weak solvent, Non-yellowing	表面处理剂 Surface-treatment agent
HDS-130YLV	29~31	1~1.5	120~150	≥300	≥200	硬质,无黄变,低粘 Hard,Non-yellowing,Low viscosity	表面处理剂 Surface-treatment agent
HDS-2150SP	34~36	0.6~1.2	140~200	≥200	≥150	硬质,高光,低粘,油滑 Hard,high gloss,Low viscosity, Oil slippery	表面处理剂 Surface-treatment agent
HDS-5016SP	49~51	1~3	140~180	≥200	≥200	硬质,高固,高光,低粘,油滑 Hard,High solid,High gloss,Low viscosity,Oil slippery	表面处理剂 Surface-treatment agent

规格 Specification	固含量 Solid Content(%)	粘度 Viscosity (10000 cps/25°C)	100%模量 100% Modulus (kg/cm ²)	抗张力 Tensile Strength (kg/cm ²)	伸长率 Elongation (%)	特性 Characteristic	用途 Uses
品名 Articles							
HDS-5180SP	49~51	2~8	190~240	≥200	≥150	高硬质,高固,高光,低粘,油滑 Hard,High solid,High gloss,Low viscosity,Oil slippery	表面处理剂 Surface-treatment agent
HDS-5070	49~51	0.5~1	60~70	≥100	≥300	中软质,高固,低粘,高亮 Medium soft,High solid,Low viscosity,High gloss	表面处理剂 Surface-treatment agent
HDS-5100LV	49~51	4~8	120~160	≥300	≥200	中硬质,高固,低粘,高亮 Medium hard,High solid, Low viscosity,High gloss	表面处理剂 Surface-treatment agent
HDS-30HP	29~31	2~6	30~40	≥300	≥500	软质,耐水解,湿涩感 Soft,Hydrolysis resistance, Wet Touch	表面处理剂 Surface-treatment agent
HDS-20HB	29~31	8~14	25~35	≥200	≥500	软质,耐水解,湿涩感 Soft,Hydrolysis resistance, Wet Touch	表面处理剂 PU film For OPP
HDS-5060P	29~31	8~14	35~45	≥300	≥500	高回弹,成膜性好 High resilience,Good film thickness	OPP膜用 Surface-treatment agent
HDS-40SL	40~44	2~5	/	/	/	龟裂 Checking	特殊用 Special Use
HDS-9306HW	25~30	0.5~1	—	—	—	耐水解好,透汽性好 Good hydrolysis resistance, Good Vapor permeability	面料 For Skin
HDA-9403HW	42~44	0.5~1	—	—	—	耐水解好,透汽性好 Good hydrolysis resistance, Good Vapor permeability	底料 For Adhesive
HDS-7060TS	35	0.5~1	—	—	—	遮盖力好,烙印变色效果佳 Good covering effect,Good embossing discoloration effect	水洗干法烙印变色 For washing embossing discoloration
HDS-2050TS	29~31	0.5~1	—	—	—	遮盖力好,烙印变色效果佳 Good covering effect,Good embossing discoloration effect	水洗干法烙印变色 For washing embossing discoloration
HDS-5200P	17~19	0.2~0.5	190~210	≥300	≥200	揉纹性好 Good grained effect	PU揉纹 For PU resin graining
HDS-3030U	29~31	8~14	25~35	≥100	≥400	软质,绒感强 Soft,Good fuzzy effect	中长毛羊巴处理剂用 For Mid and long flocking fibers of Yangba agent

合成皮革用添加剂 ADDITIVE FOR SYNTHETIC MATERIAL

规格 Specification	固含量 Solid Content(%)	粘度 Viscosity (cps/25°C)	溶剂 Solvent Component	特性 Characteristic	用途 Uses
品名 Articles					
HDN-75	73~77	2000~6000	ETAC	一般型, NCO%=12~14% General type	交联剂 Cross linking reagent
HDN-80	—	—	ETAC	高温型 High temperature type	交联剂 Cross linking reagent
HDC-02	—	—	ETAC	锡胺类 Tin and amine type	促进剂 Accelerator
HDC-06	—	—	ETAC	胺类 Amine type	促进剂 Accelerator
HDC-4020	—	—	ETAC	高温型 High temperature type	促进剂 Accelerator
A-301	—	—	—	泡孔竖直剂 Cell adjusting reagent	湿法助剂 Additive in wet process
HD-7	—	—	—	疏水性非离子表面活性剂 Non-ion surfactant with hydrophobicity	湿法助剂 Additive in wet process
HD-8	—	—	—	强疏水性非离子表面活性剂 Non-ion surfactant with strong hydrophobicity	湿法助剂 Additive in wet process
HD-F3	—	—	—	提高耐水解性 Improving hydrolysis resistance	氟系防水剂 Fluorine type water resistant

聚酯多元醇 POLYESTER POLYOL

聚酯多元醇包括常规聚酯多元醇、聚己内酯多元醇和聚碳酸酯二醇，它们含酯基或碳酸酯基，但实际上通常所指的聚酯多元醇是由二元羧酸与二元醇等通过缩聚反应得到的聚酯多元醇。

汇得科技生产的聚酯多元醇产品广泛应用于革用聚氨酯树脂、涂料、胶粘剂以及弹性体等产品中。

Polyester polyols include conventional polyester polyols, polycaprolactone polyols and polycarbonate diols. They contain esters or carbonates. However, in fact the commonly referred polyester polyols are obtained by polycondensation from binary carboxylic acids and diols. The polyester polyol products manufactured by Huide are widely used in the products such as polyurethane coatings, binders and elastomers.



聚酯多元醇 POLYESTER POLYOLS

规格 Specification	品名 Articles	分子量 M.W.	官能度 Functionality	羟值 OH Value (mgKOH/g)	酸值 Acid Value (mgKOH/g)	粘度 Viscosity (cps)	用途 Uses
EG/AA系列	HDPOL-2205	700	2.00	150-170	0.5	—	涂料, 粘合剂, 弹性体 Paint, Adhesive, Elastomer
	HDPOL-2210	1000	2.00	106-118	0.5	285-335/60°C	涂料, 粘合剂, 弹性体 Paint, Adhesive, Elastomer
	HDPOL-2220	2000	2.00	53-59	0.5	500-600/75°C	涂料, 粘合剂, 弹性体 Paint, Adhesive, Elastomer
	HDPOL-2230	3000	2.00	35-39	0.5	—	涂料, 粘合剂, 弹性体 Paint, Adhesive, Elastomer
NPG/AA系列	HDPOL-3305	700	2.00	150-170	0.5	—	涂料, 粘合剂 Paint, Adhesive
	HDPOL-3310	1000	2.00	106-118	0.5	—	涂料, 粘合剂 Paint, Adhesive
	HDPOL-3320	2000	2.00	53-59	0.5	420-520/100°C	涂料, 粘合剂 Paint, Adhesive
BG/AA系列	HDPOL-4405	700	2.00	150-170	0.5	—	涂料, 粘合剂, 弹性体 Paint, Adhesive, Elastomer
	HDPOL-4410	1000	2.00	108-118	0.5	300-360/60°C	涂料, 粘合剂, 弹性体 Paint, Adhesive, Elastomer
	HDPOL-4420	2000	2.00	53-59	0.5	620-740/75°C	涂料, 粘合剂, 弹性体 Paint, Adhesive, Elastomer
	HDPOL-4430	3000	2.00	35-39	0.5	720-840/100°C	涂料, 粘合剂, 弹性体 Paint, Adhesive, Elastomer
DEG/AA系列	HDPOL-5510	1000	2.00	106-118	0.5	—	弹性体 Elastomer
	HDPOL-5520	2000	2.00	53-59	0.5	420-520/75°C	弹性体 Elastomer
	HDPOL-5530	3000	2.00	35-39	0.5	450-550/100°C	弹性体 Elastomer
MPD/AA系列	HDPOL-5510M	1000	2.00	106-118	0.5	—	弹性体 Elastomer
	HDPOL-5520M	2000	2.00	53-59	0.5	450-550/75°C	弹性体 Elastomer
	HDPOL-5530M	3000	2.00	35-39	0.5	580-720/100°C	弹性体 Elastomer
HD/AA系列	HDPOL-6610	1000	2.00	106-118	0.5	210-270/60°C	涂料, 粘合剂, 弹性体 Paint, Adhesive, Elastomer
	HDPOL-6620	2000	2.00	53-59	0.5	—	涂料, 粘合剂, 弹性体 Paint, Adhesive, Elastomer
	HDPOL-6640	4000	2.00	26-30	0.5	700-860/120°C	涂料, 粘合剂, 弹性体 Paint, Adhesive, Elastomer
EG.NPG/ AA系列	HDPOL-2320	2000	2.00	53-59	0.5	600-740/75°C	涂料, 粘合剂, 弹性体 Paint, Adhesive, Elastomer

规格 Specification	品名 Articles	分子量 M.W.	官能度 Functionality	羟值 OH Value (mgKOH/g)	酸值 Acid Value (mgKOH/g)	粘度 Viscosity (cps)	用途 Uses
EG.BG/AA系列	HDPOL-2405	700	2.00	150-170	0.5	—	涂料, 粘合剂, 弹性体 Paint, Adhesive, Elastomer
	HDPOL-2410	1000	2.00	108-116	0.5	300-360/60°C	涂料, 粘合剂, 弹性体 Paint, Adhesive, Elastomer
	HDPOL-2420	2000	2.00	53-59	0.5	550-670/75°C	涂料, 粘合剂, 弹性体 Paint, Adhesive, Elastomer
	HDPOL-2430	3000	2.00	35-39	0.5	580-720/100°C	涂料, 粘合剂, 弹性体 Paint, Adhesive, Elastomer
EG.DEG/ AA系列	HDPOL-2440	4000	2.00	26-30	0.5	800-960/120°C	涂料, 粘合剂, 弹性体 Paint, Adhesive, Elastomer
	HDPOL-2510	1000	2.00	106-118	0.5	270-330/60°C	涂料, 粘合剂, 弹性体 Paint, Adhesive, Elastomer
	HDPOL-2520	2000	2.00	53-59	0.5	440-560/75°C	涂料, 粘合剂, 弹性体 Paint, Adhesive, Elastomer
BG.NPG/ AA系列	HDPOL-2530	3000	2.00	35-39	0.5	430-550/100°C	涂料, 粘合剂, 弹性体 Paint, Adhesive, Elastomer
	HDPOL-4305	700	2.00	150-170	0.5	—	涂料, 粘合剂, 弹性体 Paint, Adhesive, Elastomer
	HDPOL-4310	1000	2.00	106-118	0.5	—	涂料, 粘合剂, 弹性体 Paint, Adhesive, Elastomer
BG.DEG/ AA系列	HDPOL-4320	2000	2.00	53-59	0.5	700-840/75°C	涂料, 粘合剂, 弹性体 Paint, Adhesive, Elastomer
	HDPOL-4530	3000	2.00	35-39	0.5	560-700/100°C	涂料, 粘合剂, 弹性体 Paint, Adhesive, Elastomer
HD.NPG/ AA系列	HDPOL-6310	1000	2.00	106-118	0.5	—	涂料, 粘合剂, 弹性体 Paint, Adhesive, Elastomer
	HDPOL-6315	1500	2.00	72-78	0.5	650-750/60°C	涂料, 粘合剂, 弹性体 Paint, Adhesive, Elastomer
	HDPOL-6320	2000	2.00	53-59	0.5	610-710/75°C	涂料, 粘合剂, 弹性体 Paint, Adhesive, Elastomer
EG.DEG.TMP/ AA系列	HDPOL-2527	2700	2.65	52-58	0.6	430-590/100°C	涂料, 粘合剂, 弹性体 Paint, Adhesive, Elastomer
	HDPOL-2525	2500	2.04	43-48	0.6	710-890/75°C	涂料, 粘合剂, 弹性体 Paint, Adhesive, Elastomer
	HDPOL-2521	2100	2.14	53-59	0.4-0.8	540-680/75°C	涂料, 粘合剂, 弹性体 Paint, Adhesive, Elastomer
BG.MPO/ AA系列	HDPOL-2001	2000	2.00	53-59	0.5	680-780/75°C	涂料, 粘合剂, 弹性体 Paint, Adhesive, Elastomer
EG.MPO/ AA系列	HDPOL-710	1000	2.00	106-118	0.5	280-340/60°C	涂料, 粘合剂, 弹性体 Paint, Adhesive, Elastomer
	HDPOL-9520	2000	2.00	53-59	0.5	530-650/75°C	涂料, 粘合剂, 弹性体 Paint, Adhesive, Elastomer
	HDPOL-721	2000	2.00	53-59	0.5	540-680/75°C	涂料, 粘合剂, 弹性体 Paint, Adhesive, Elastomer
DEG/PA系列	HDPOL-340	350	2.00	310-330	1.0	310-370/50°C	弹性体 Elastomer
EG.DEG/ PA.AA系列	HDPOL-1650	1650	2.00	65-71	0.8	590-730/75°C	涂料, 粘合剂, 弹性体 Paint, Adhesive, Elastomer

工艺流程图 PROCESS FLOW DIAGRAM

无溶剂高速混合配料加工流程图

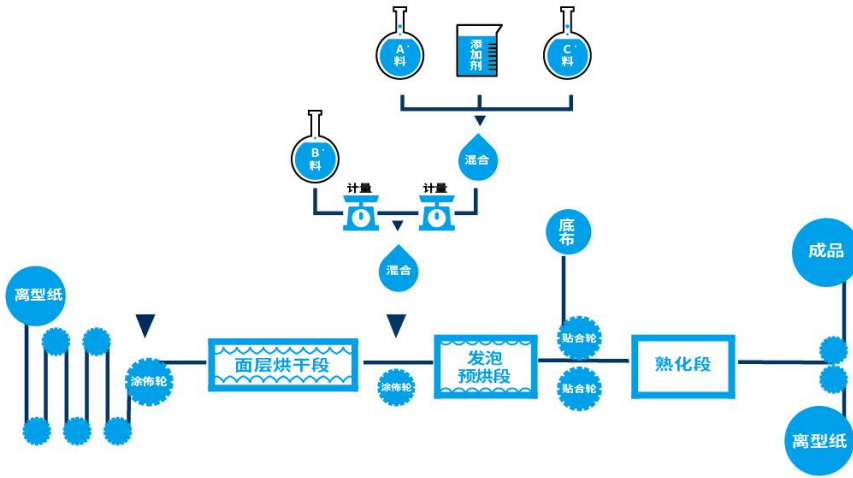

干法复合流程图-布复合

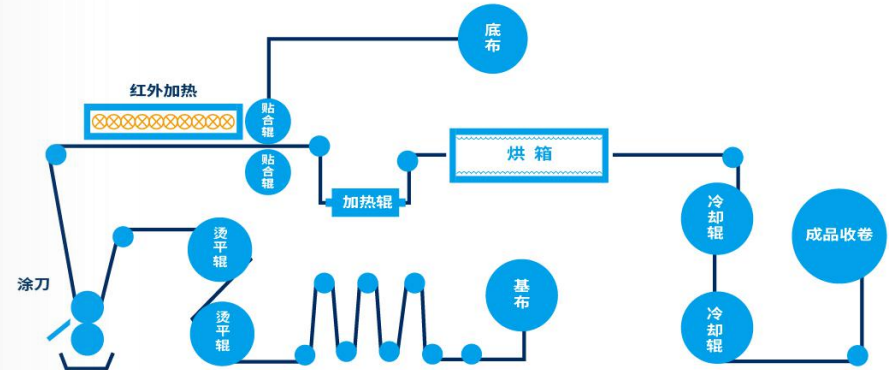

干法线流程图-三涂四烘

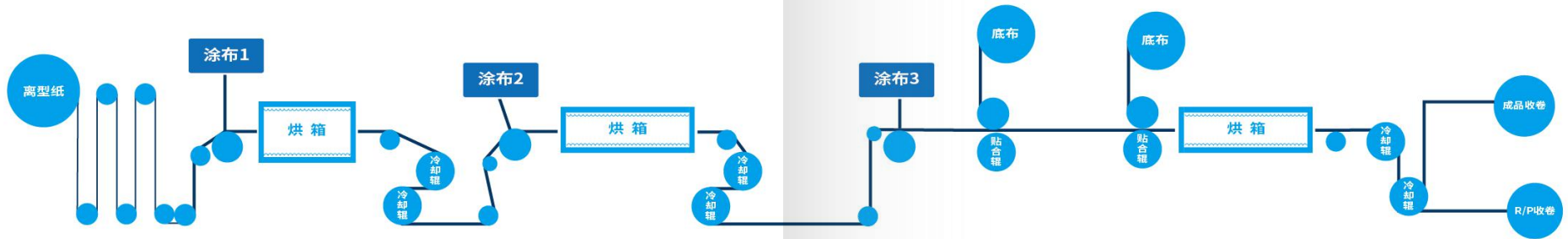

磨砂流程图

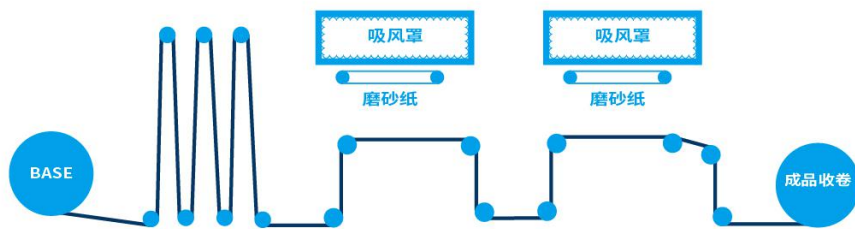

印刷、压纹线流程图-三版印刷, 压花

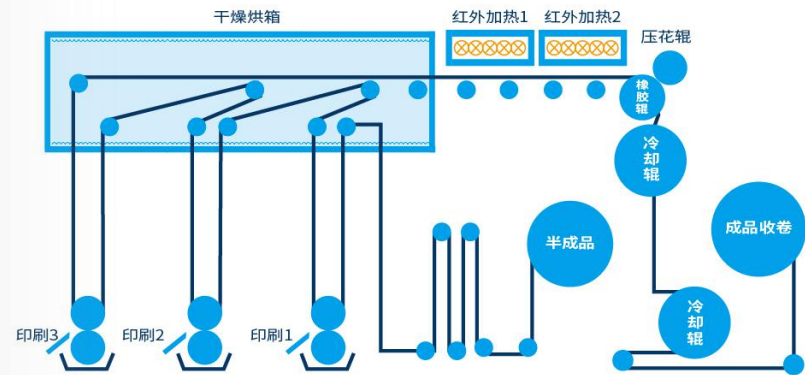

湿法线流程图

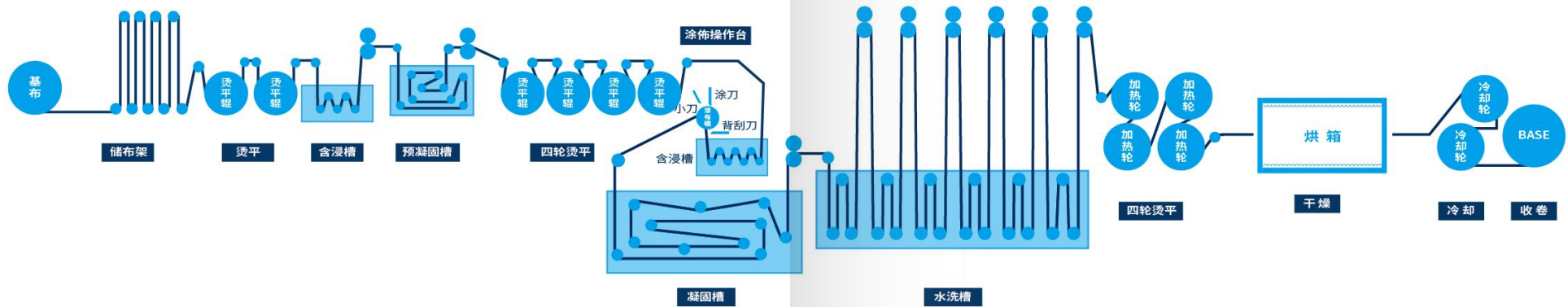



上海汇得科技股份有限公司
SHANGHAI HUIDE SCIENCE & TECHNOLOGY CO., LTD.

上海市金山区金山卫镇春华路 180号(上海精细化工产业园区) 邮编: 201512
电话: 86-21-37285599-809 86-21-37285599-810 86-21-37285390 传真: 86-21-37285395
网址: www.shhdsz.com
